

**Firenock**  
The Science of Archery™

2024

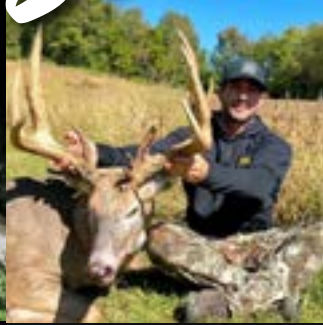
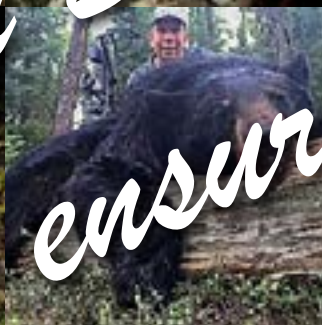
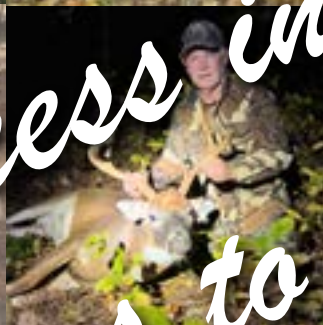

Your success in  
2023  
continues to ensure  
our success  
in  
2024

# Firenock®

## ...NOT JUST A LIGHTED NOCK COMPANY

### Founder's Note

A few years ago, this catalog was less than half the length that it is currently. And while there have been a few new products since then, the main cause for this rapid growth is our decision to become more intentional. More so, specifically, with how we market ourselves. While our lighted nocks are still the most advanced of their kind and remain one of our top sellers, they've not been our only product since 2008. Branching into nearly realm of the archery business for over fifteen years and now awarded with 43 US patents and counting, Firenock is not only "The Most Advanced Lighted Nock." Today we are "The Science of Archery."

## Firenock®

### The Science of Archery™

This new tagline, in sum, means that everything we do and put out is founded from our unique take on archery—that archery is, in fact, a science i.e., an enterprise that's knowledge should be systematically tested, shared, compared, and pushed to its limits. Why? Because so much of archery involves science, physics especially. Each time you pull your bow or crossbow back, there are dozens of forces working together (and, unfortunately, more often than not, not working together) to ultimately launch a high-speed, high-energized projectile over space. Shouldn't, then, the variables that cause those very forces to begin with be optimized? Every element, from the bow itself to the smallest arrow component, matters.

For so long, many of archery's methods and techniques have been unchallenged. The processes used today to prepare and build full setups have been unchanged for decades. And worse, when problems inevitably arose, like those that did when the speed threshold passed 315fps, they were solved with simple stopgaps. Firenock has always stood for and done the opposite.

With each and every advancement, Firenock has done extensive research on what existed and what exists. We survey hobbyists to archery Olympic Gold-medalists and ask what works and what does not work. Then, once we build working prototypes from the functional and non-functional requirements rendered via those investigations, we test them. Over and over, making slight alterations each time. Because, as aforementioned, we view archery as a science and as any good scientists would do, our "hypotheses" are highly scrutinized before publication. Therefore, when a Firenock product is revealed, it is because and only because it is the best iteration of that product possible. In fact, they are at least fifty percent better—via design, feature, and/or material—than anything that existed prior. The only updates or revisions that occur post are when archery paradigms like typical use cases shift and evolve.

### The Catalog

A catalog is by definition meant to entice customers to make a purchase decision. At Firenock, our catalog is painstakingly composed with an additional intention: to empower customers to make *educated* decisions. While we want our products to be purchased, we hope too that our customers learn to step back and rethink. Rethink with the knowledge of what components and accessories, what variables, work together/work against each other to influence their bow and arrow.

Examples of new additions made to the catalog include the brand new "Science of Archery" section, an improved AeroFlight 101 spread, updated series summaries, and all new product comparisons. Check out the redesigned table of contents on the next page for details.

In conclusion, we at Firenock sincerely hope that our intentionality provides you with a better understanding as well as appreciation of the world of the Science of Archery.



Dorge Huang, Archery Scientist

### WARRANTY

All Firenock LLC products purchased through the Firenock webstore, <https://www.firenock.com>, have a 30 days no-fault, unconditional exchange/refund guarantee. This service is only available in the USA.

### FLNS LIFETIME REFRESH/SIDE-GRADE SERVICE

Firenock lighted nock systems are eligible for our lifetime refresh/side-grade service. In other words, you can get the latest Firenock circuits (any function and any LED color) as well as new polycarbonate nocks (any style and any color) with a small fee. This service is only valid when a completed form and appropriate funds are sent along with previously purchased lighted nocks and/or circuit(s). Note that O-rings and batteries should not be sent. We cannot be responsible for anything that is not part of the refresh service. Additional accessories can be included at list price with no additional shipping and handling fee. For more details, please visit <https://www.firenock.com/warranty/> or contact us at (815) 780-1695.

## TABLE OF CONTENTS

The catalog is now organized into four major sections for your convenience: The Science of Archery, AeroComponents, Bow Accessories, and Preparation Tools.

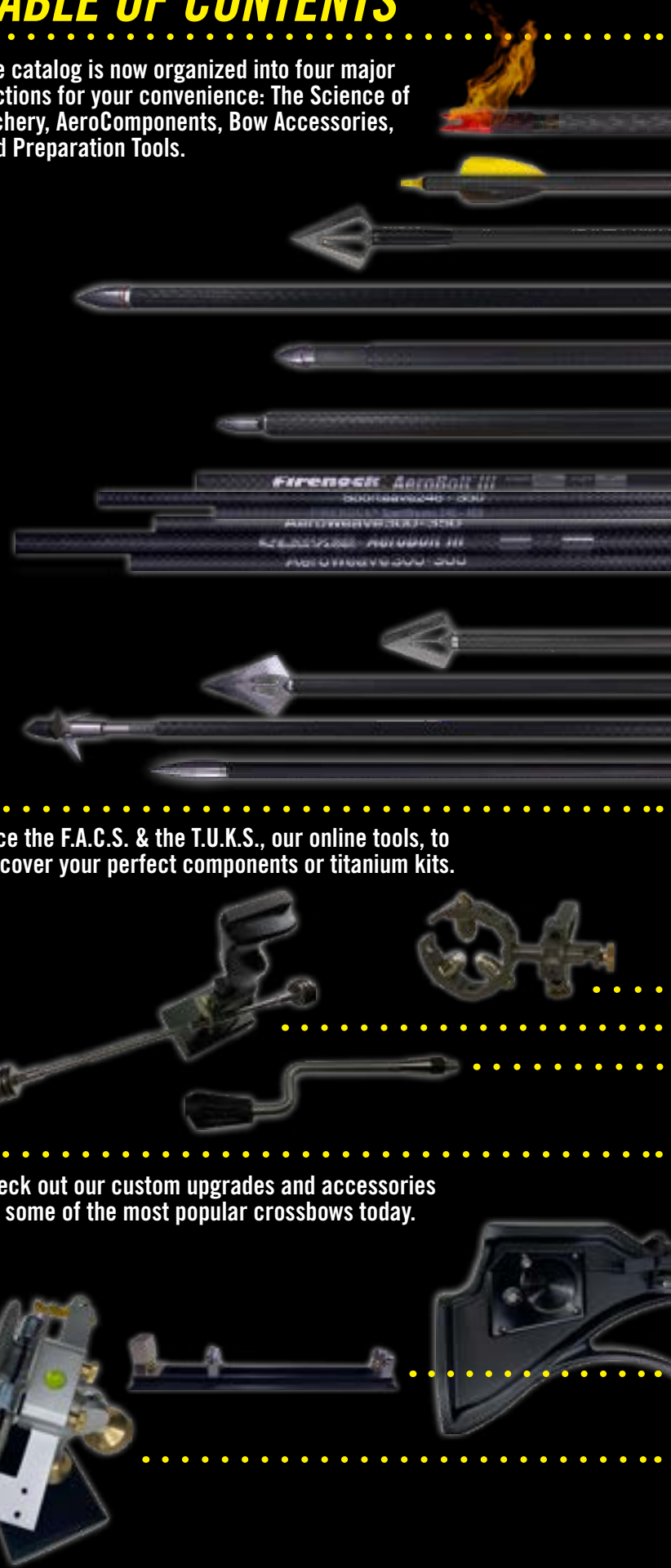

Face the F.A.C.S. & the T.U.K.S., our online tools, to discover your perfect components or titanium kits.

Check out our custom upgrades and accessories for some of the most popular crossbows today.

Founder's Note	2
<b>THE SCIENCE OF ARCHERY</b>	4
<b>AEROCOMPONENTS</b>	12
Firenock Lighted Nock System	14
Aerovane®	18
<b>AeroSystem</b>	
AeroBushing™ & AeroOutsert™	20
AeroPoint™ & AeroInsert-A™	22
<b>AeroConcept System</b>	
CTI & AeroInsert-H™	24
AC Points & Destroyer Series	26
<b>Projectiles</b>	
AeroBolt™ (Crossbow Bolts)	28
AeroWeave™ & SportWeave™	30
<b>Broadheads</b>	
Spacers & Traumahawk™	34
Dagger, Stalker Dagger	36
SwingBlade™ (Mechanical)	38
Stalker, Stalker SwingBlade	40
Firenock AeroComponent Selector	44
<b>BOW ACCESSORIES</b>	46
Titanium Upgrade Kit Selector	48
<b>For Vertical Bow</b>	
AeroRest™ Arrow Rest	50
AeroStab™ Stabilizer	52
AeroBump™ String Bump	54
<b>For Crossbow</b>	
Ravin Upgrades	56
AeroCrank-AD	58
Scorpyd & PSE TAC Upgrades	60
TenPoint Upgrades	61
<b>PREPARATION TOOLS</b>	62
Glue, APS, & APSSSS	64
PAPS (Spine Index Locator)	66
Aerovane Jig	68
ABSSJ (String Serving Jig)	70
ABSSJ-TD (Twin Drag)	71

# THE SCIENCE OF ARCHERY

How did the field of archery become what it is today? We'll become familiar with how arrows (and objects like arrows) have been built over time. After that, we'll dive into some of the elements of arrow flight, bust some common industry myths, and, finally, cross-examine some arrow components.

## Arrow Materials

What were arrows originally made of? At least in recorded history, raw bamboo is the first material used to build arrows. Naturally very straight, bamboo is a reasonable solution for arrow building.

For a more dependable arrow, more recent versions of bamboo arrows involve the use of treated split bamboo. This takes advantage of the natural straightness of raw bamboo but is more consistent due to some processing.

Another classic material is wood. Common tree species used include cedar, ash, poplar and hickory. Note that, besides natural straightness, arrows made of wood are usually quieter during flight because they are solid versus hollow (like bamboo). This is, of course, based on the assumption that the wood used to make wooden arrows is perfectly consistent. And, although processed, trees grow unevenly and imperfectly.

Shifting to more modern materials, aluminum arrows appeared on the market in the past few decades. Often extruded, solid aluminum arrows have great straightness and a true linear spine. The main negative with aluminum arrows, however, is their fragility. Their torque, torsion, and loop strength (we'll get to those terms on the next page) is substandard, leading to a higher chance of ruined arrows.

Another common, more modern arrow material is fiberglass. Again with a decent straightness as well as a linear spine, this material has a great disadvantage—weight.

As we all know, the most popular arrow shaft material today is carbon. There are several forms of carbon currently utilized by arrow manufacturers, but the most common forms include extruded, cloth, and woven. Firenock takes advantage of the highly durable and manipulable carbon weave. Learn more on the AeroWeave and SportWeave spreads.

## Carbon Usage

Carbon is a popular material for more than just arrow shafts. Fishing rods, lacrosse sticks, golf clubs, and ski poles are all often made of or available in carbon. Notably, in one way or another, all of these examples are sports equipment. There is a reason for this. To understand this reason in relation to arrows however, consider these two major differences between an arrow and all the other objects:

**Tapered vs. Parallel.** While all of the presented example objects are based on carbon tubes, they are all also usually tapered in shape. Tapering forces a shaft to have a linear spine. Unless made of a homogeneous material like aluminum, arrows are not tapered and do not have a linear spine.

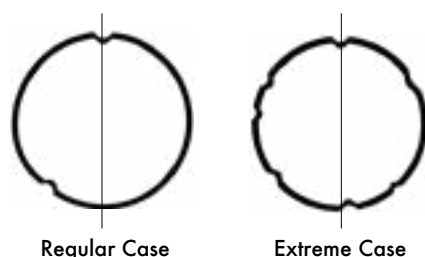

But how do we know that? If a spine is not linear, what is it? In short, when carbon is rolled, the "spine" is almost always curved. The two diagrams above are exaggerated to illustrate the "valleys" or cave-ins that represent the first and subsequent dynamic bends (you'll learn more about them in detail later). The left is the most common case because there are two "valleys" so it is easy to distinguish which is the first dynamic bend. The right is an extreme example; if you ever come across such an arrow, it should not be used. The only sure way to locate an arrow's FDB(s) is via the Firenock Professional Arrow Preparation System (PAPS).

**Anchored vs. Free.** Considering the sample objects again, notice how they all have handles that allow for manual control. After an arrow leaves your bow, it is out of your control. Therefore, it is crucial to make an arrow's flight predictable, which is only possible through knowledge of your FDB.

## Arrow Vanes

Vanes are arguably the arrow component that has changed the most in the past fifty or so years. To illustrate the impact of this rapid evolution, checkpoints in time have been summarized below. Additionally, reflect on this quote from our aerospace consultant Professor Michael S. Selig of the University of Illinois at Urbana-Champaign (UIUC): "Birds don't fly with feathers, they fly with wings."

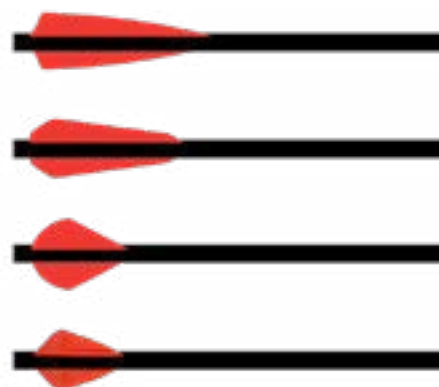

**-1960s:** Vanes until the past mid-late century were most often several inches long and made of feathers. Longbows and the compound bows were pushing maximum 120-150fps, so these vanes and their use of drag sufficed.

**2000s:** With the advancement of compound bow technology came the surpassing of 200fps as well as the surge of plastic vanes. Coincidentally, vanes also became shorter at this time.

**2010s:** Bohning purchased Blazer and marketed it until it became the number one vane (it remains so to this day). Though about the length of an Aerovane, its larger height leads to a larger crosswind signature. Further, vanes still utilized drag, wasting energy.

**NOW:** As vertical bows begin to regularly push 300fps, drag does not suffice. Only vanes that lift, such as the Aerovane with its custom airfoils, can quietly and efficiently fly at such speeds.

# AEROHISTORY

Now with a general understanding of arrow history, how are carbon arrows made today?

## Spine & Deflection

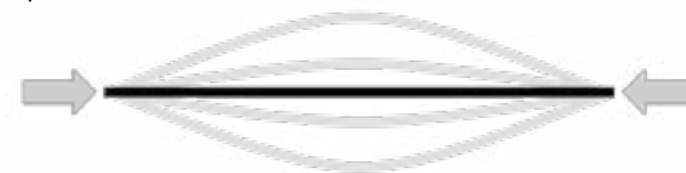

## Unidirectional Construction

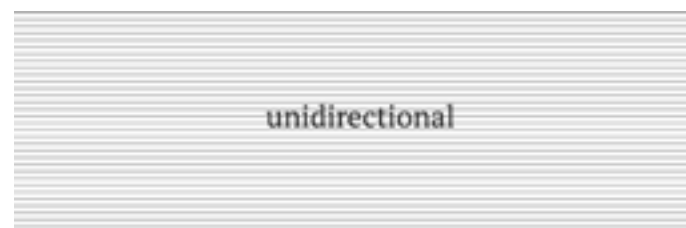

## Loop Strength

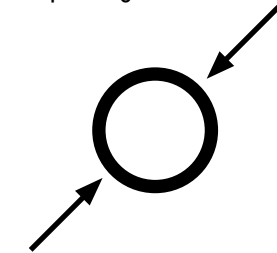

## Torque Strength

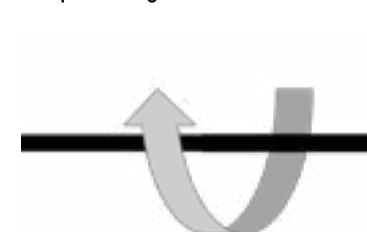

## Torsion Strength



## Cross-directional Construction

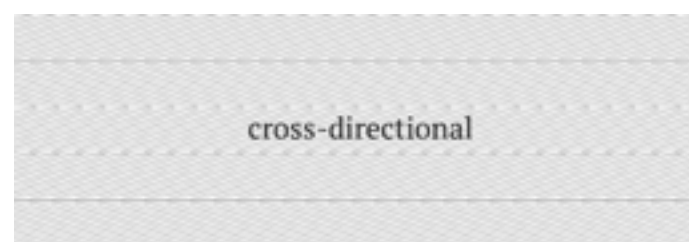

## Combination Construction

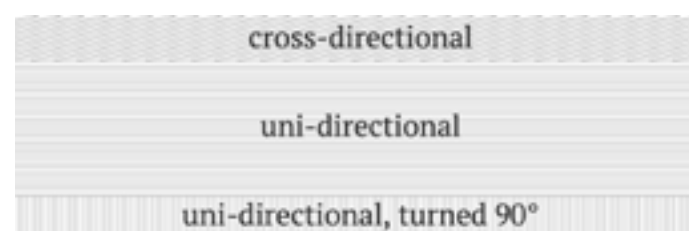

We believe that the feature that matters the most is spine and deflection. While we touched on linear versus curved spine on the previous page, the word "spine" is also used to describe an arrow's overall stiffness. More specifically, it is how resistant an arrow shaft is to being bent. Spine deflection, therefore, is how to measure that resistance. The more an arrow deflects at x pressure (especially that from a direct force to its ends), the higher the spine. What else matters though?

As you can see from the arrow construction example on the left, the first generation of arrows' carbon fibers were set in simple linear rows before being rolled up. This method, although simple, does have benefits. Very light, unidirectionally laid arrows also have a very strong, very defined spine. There are issues too, however.

What measures are used to test the quality of an arrow? For this analysis, we will be using three measures in addition to spine: loop strength, torque strength, and torsion strength. Loop strength, simply put, is how much resistance an arrow has to direct compression. Torque and torsion strength, on the other hand, are a bit connected. Both have to do with how much resistance an arrow has to being bent. The difference between them, then, is that while torque strength is associated with bending via one axis, torsion strength is associated with two or more axes. As an arrow is oscillating in space after launch, it is arguably bending/twisting on an infinite amount of axes.

## To the current generation of arrow production.

The main issue with the first generation's construction was how limited the aspect of the fibers were. Though this feature was actually what gave it its few pros (solidity/rigidity = strong spine), the cons outweighed them and arrow manufacturers quickly adopted a new construction: the cross-directional or helix wrap. Though its spine is not as strong or as light as the original, it has some loop strength and torque strength. As its name implies, this construction is based on crossed directions, covering two angles, maximum three if one part of the lay is uneven. Unfortunately, however, as the chance for a hit from any angle is always possible in the world of archery, two or three protected angles is not nearly enough.

The bottom image to the left is an example of another popular arrow construction that is used today. A combination of the fiber lays of the previous two constructions, this wrap is relatively lightweight (unidirectional) with more loop strength and torque strength (cross-directional/turned uni-directional). While it protects more axes, combination construction like these do not meet today's high-speed, high-energy requirements. The AeroWeave does.

# AEROFLIGHT A New Spin on Arrow Flight

This spread will introduce some lesser known but nonetheless essential factors about arrow flight—AeroFlight. In summary, the three factors/topics that are addressed are the null point or node, general rotation versus torque-induced or gyroscopic precession, and oscillation as well as its resulting motions.

## The Null Point

The null point or node (red dot) is the unique segment of an arrow where no vertical or horizontal movement occurs at initial launch.



*\*This diagram exaggerates its subject for illustrative purposes*

But [1] how do you find it, [2] why should you find it and [3] what do you do with it after you find it?

1. Loosely hold a complete arrow by its nock end and knock it on a hard surface from a few inches away until you hear a solid shift in tone. The arrow should also not bounce when the node is located.
2. Your arrow rest should match up with the node when you pull back. That way, there will be a minimal chance of your arrow skewing away from true center at initial launch.
3. To take full advantage of your arrow's inherited null point, use it when tuning your archery setup today.

## Rotation versus Torque-Induced Precession

Torque-induced or gyroscopic precession is a fancy word used to describe any motion similar to that of a top i.e., any motion that rotates around a singular axis with an additional, external torque applied to it. In the case of an arrow, the shaft itself is the central axis, while the external torque is the circular lift. Before continuing, note the resulting trajectory of an average arrow that experiences standard or general rotation in the diagram below.

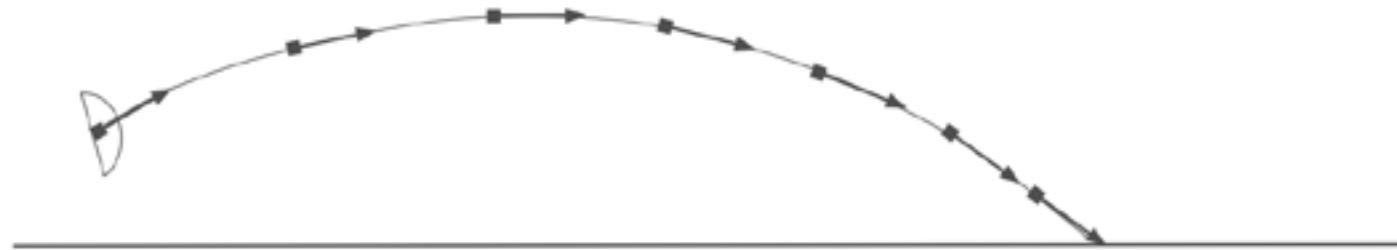

*\*This diagram exaggerates its subject for illustrative purposes*

After leaving your bow, an average arrow flies on a parabolic path and usually sticks the target at an acute angle. In the case of gyroscopic precession, however, in an identical setup, the trajectory of flight is very different (below). Often, the slope of the latter end of the path is flatter and the arrow itself "sticks" or ends up hitting your target head-on. This change, as aforementioned, is due that additional torque/force—circular lift—which feeds the rotational energy of the arrow. You can take advantage of this factor only through the use of AeroVane II or 3 due to its significantly high rotation rate.

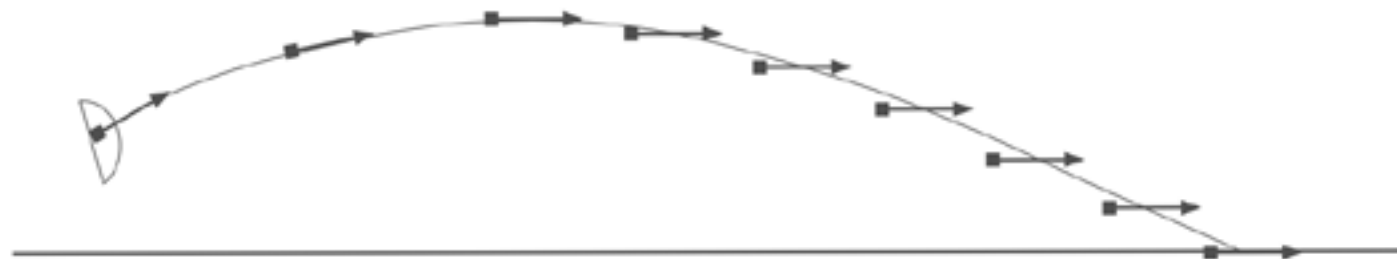

*\*This diagram exaggerates its subject for illustrative purposes*

# Another Flight Revolution AEROFLIGHT

## Oscillation & Its Resulting Motions

Consider this—your arrow oscillates during flight. And during this oscillation process, a lot of energy is lost. This is because your shot arrow, as any object with energy, needs to reach an equilibrium.

Pictured at the top right, the ideal arrow motion scenario (and, unfortunately, the one most believe to always be the case) is a linear flex [0, left] through a center point where the first (red dot) and second dynamic bend (blue dot) are 180 degrees from one another. This would result in the expense of the minimum amount of elastic energy lost. Further, even if it was to flex in a parabolic motion [0, right] the true center of the shaft would always be maintained.

Such a scenario is only the "ideal" today and even a perfectly extruded aluminum arrow would not move in this fashion. Remember those "valleys" from the previous spread? To reach that "equilibrium," an arrow, no matter how "perfect," will sporadically flex and bend during flight.

Exactly how sporadic an arrow's movement is during oscillation depends on how its three central resulting motions manifest and interact with one another. Note that they all also happen simultaneously.

1. Actual linear flex occurs through a first (red dot) and a second dynamic bend (blue dot), but not 180 degrees from one another. Instead, common pairings will be at something like twelve and four o'clock (120 degrees) or twelve and seven o'clock (-150 degrees). This motion results in the deformation of the center of the arrow from round to elliptical and many times, off-center elliptical.
2. Torsion, or opposite circular longitudinal flex, occurs when an arrow is flexing linearly at both ends in at least two opposite directions. This motion is a byproduct of the previous motion, actual linear flex.
3. Finally, as another byproduct of actual linear flex, an off-center rotation occurs. This rotation is due specifically to the aforementioned deformation of the round shape of the shaft and follows a parabolic path.

All in all, by understanding the complex phenomenon that happens during arrow oscillation—by understanding the what and the why of each action—Firenock is able to develop and patent products like the AeroWeave.

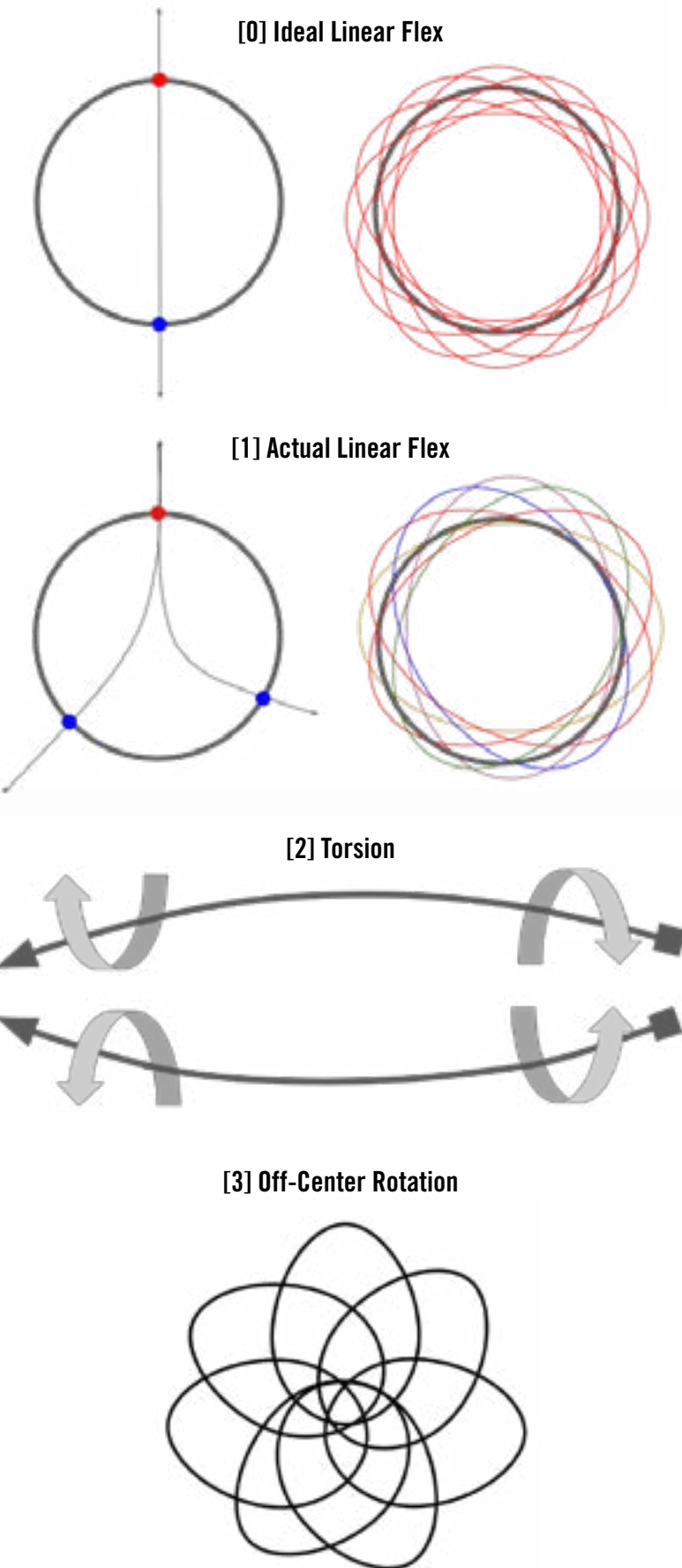

With today's high-speed archery projectiles, much of what we know about how an arrow responds and flies in the air needs to be re-addressed. Variables that were once considered essential no longer hold the same weight. The standard draw-cycle looks more and more like that from a bow with an over 70% let-off. The rate of energy used must change more drastically and more violently than ever before, further taxing an arrow's recovery speed. What does that mean for industry rules of thumb?

## Myth #1: The arrow must be straight to shoot right.

Many of today's archers are obsessed with the need to have "perfect" arrow straightness. This originates from the belief that arrow straightness means more stable arrow launch, better arrow recovery, and therefore accuracy. From our research however, we learned that arrows actually flex no less than 0.050" throughout their entire flight and, often, flex more than 0.500" at initial launch. Further, now almost ten years ago, we concluded that arrows with a straightness as much as 0.008" will fly nearly the same as those with 0.001" straightness as long as something we call their "first dynamic bend" direction are matched. Because, as seen in the large amount of flexing demonstrated during the first few moments after launch, it is not the straightness of the arrow that matters but that matching of the "first dynamic bend" or first direction of flex. Learn more about this phenomena on the PAPS spread.

**Truth #1: The first dynamic bend is more crucial than arrow straightness.**

## Myth #2: The thinner the arrow, the better.

Another trend that archers today are obsessed with is smaller diameter arrows. There are three large assumptions about thinner arrows [1] they are more aerodynamic, [2] they cause deeper penetration and [3] they allow an arrow to reach equilibrium faster.

The first of these assumptions is easily debunked because crosswind signature i.e. the total affected area through space ultimately depends on the component with the largest diameter i.e. the field point or broadhead, never the arrow shaft. The next two assumptions, however, take a bit more explanation.

In the previous section, we uncovered the fact that arrows flex throughout their entire launch cycle. Additionally, we learned that we could control that cycle by finding and matching arrows' first dynamic bends. Because beside being the byproduct of an arrow's recovery, the initial flex of an arrow is how energy is transferred from the bow to the shaft. But what if the arrow itself limited its own capacity to efficiently transfer energy? This is the case with thinner arrows.

Thinner arrows give shooters the false sense that their arrows have a higher spine than their rating due to a thinner diameter meaning a higher difficulty to deform into an oval shape. But this thinner diameter actually also means a thicker sidewall and a less responsive arrow shaft. If an arrow has to work harder i.e. flex more, it will waste more energy overall. Causing shallower penetration and a longer duration of time to reach equilibrium.

The smaller the diameter of the shaft, the longer it flexes in the air due to residual energy stored in its thicker walls. From our research using slow-motion cameras, we discovered that the ideal diameter for hunting arrows is 0.202-0.204" ID while for target arrows is 0.300" ID.

**Truth #2: Thinner diameter arrows mean thicker walls, which do not a better arrow make (<0.202" ID).**

## Myth #3: The higher the FOC, the better control you have over your arrow.

The last obsession we need to debunk is high FOC. It is assumed that the more weight-forward an arrow is, the more stable and therefore accurate it is. And while this is technically true, it is only so when all the afore preferences are compounded. When [1] the bow has a let-off of over 70%, [2] an arrow's walls are thicker than that of a standard 0.202" ID arrow, and [3] the arrow has a "correct" spine based on poundage and draw length, the more exaggerated problems appear. Why? Because with such a combination (which is actually becoming only more and more popular), the flex of the arrow is more dramatic and prolonged. How? Because the greater mass ratio at the front end causes the tail end of an arrow to flex more, increasing the amount of drag and ultimately wasting energy. In the end, a high FOC is counterproductive. As FOC increases, although we are supposed to be getting better direction control, in the case of today's high let-off, high-speed archery projectiles, we actually lose the energy retention capacity of an arrow.

**Truth #3: FOC is only one of many variables that cumulatively help control arrow flight.**

The Firenock lighted nock system (FLNS) was our first product and remains to this day our #1 series. The high standards that we abide by today for every lineup were learned during the research and design phase of this system. We've talked about arrows, but what about their components? Let's start with nocks.

## What Makes a Good (Lighted) Nock?

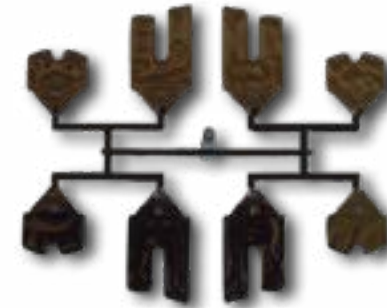

Put shortly, not this. Firenock believes that good polycarbonate nocks start with good manufacturing standards. This image is an output of a simple plastic mold. At its center are the remains of where the plastic was injected. In this instance, there were two pieces molded four at a time. Another way of describing it is eight "cavities" per mold. Notice that the pieces are evenly and symmetrically spaced. This was an attempt from the manufacturers to manipulate the plastic to flow in a uniform manner.

The more complex the design—as is undoubtedly the case for Firenock nocks—the more difficult it is to create a good mold. The farther an individual cavity is from the injection point, the higher the chance of uneven distribution. For consistency in weight and performance, each Firenock nock is made from a single cavity and mold.

## Virgin Flow

Firenock went another step further. Usually after plastic in a mold hardens, the excess is scraped off, re-ground, and re-melted to be re-utilized. Every Firenock polycarbonate nock are instead injected via a virgin flow i.e., never composed of recycled materials. You can tell from how clear our nocks are—test it by holding one up to the light! There are no specs or bubbles.

## Translucency

Note the differences between the molecular structures of an opaque versus translucent plastic at the right.

Until recently, plastic nocks were opaque. Due to the rise in lighted nocks, many manufacturers today have taken to translucent nocks. They

and nock consumers, however, have not taken or are not aware of the discretion required. Namely, like glass, the molecular structure of translucent nocks is non-rigid and thus susceptible to scoring and breaking. Heed and advise others to replace a translucent nock whenever it has traveled through an animal, through a target, or into the ground. Firenock "plain" nocks are available in packs of 7, 12, and 100.

## Compression System

Firenock believes good nocks must also have excellent compression capabilities. Traditional nocks have six or eight notches equidistant from one another i.e., 60 (360/60 = 6) or 45 (360/45 = 8) degrees. Firenock nocks, on the other hand, have four notches that are respectively 60 and/or 100 degrees from one another. With this notch configuration, nocks can be compressed to properly fit a range of sizes. Additionally, if it compresses well, it's much more flexible, therefore less viable to cracking.

## Shear Lock/Release System

Recall that the only contact point between the bow and the shooter is the nock. A nock's primary purpose is to engage with and disengage from a bow string. During this dis/engagement, it's logical that only one point of contact is necessary, right? Well, unfortunately, there are multiple nocks today that involve multiple points of contact between the nock and string during dis/engagement. This can waste energy and decrease accuracy.

Patented and indeed like a "shear," the Firenock nock throat is designed like a trigger (see red dots and arrows to the bottom right). At and only at the moment of arrow release, the nock throat opens up and the string cleanly passes through.

Firenock lighted nock system is more than a good nock. Discover why Firenock is the most advanced lighted nock system on its dedicated spreads.

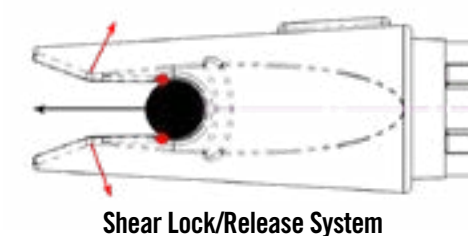
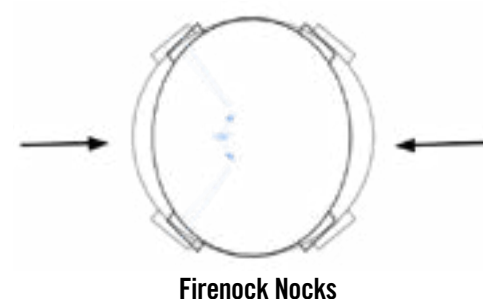
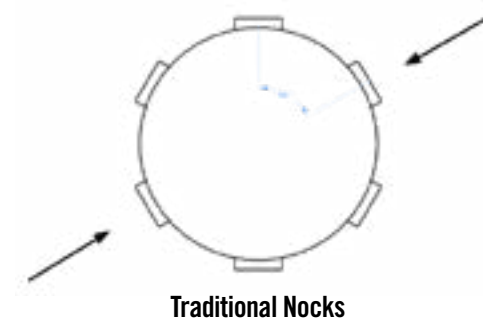
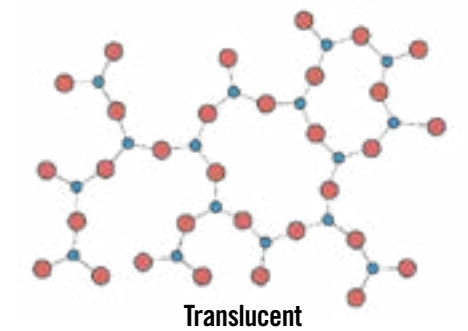
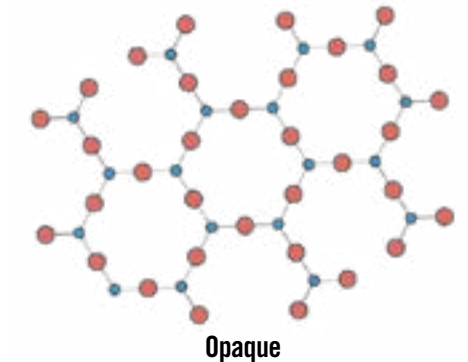

The AeroSystem includes the AeroBushing, the AeroOutsert, the AeroInsert-A, and the AeroPoint. Each of these products are standalone and can be added to your current setup immediately. At Firenock, we do not invest in the development in a product unless we believe our take will be at least 50% better than what already exists on the market. To illustrate our thought processes, we've broken down some major concerns and technological solutions for each. This page covers nock uni-bushings and outserts.

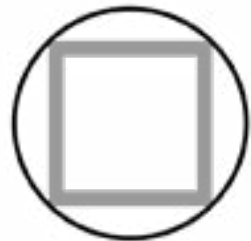

Square in a Circle



"Umbrella" Collar

## Uni-bushings 101

Traditionally, uni-bushings are made from bar stock, often weighting about 20-32 grains, and are manufactured via a screw machine that provides, at best, an approximate fit. Target archers often attempt to solve this problem by using materials like plastic bags to shim fit their bushings. The AeroBushing and its two primary, patented technologies ensure a perfect fit and self-concentricity.

### Square in a Circle Technology

The AeroBushing's design, as implied, is based off the idea of a square peg in a round hole. The problem with standard uni-bushings is that they are limited by their diameter. With, instead, only four points of contact, an AeroBushing pushes against the inside walls of the shaft to find its center. Additionally, with its skeletonized shape and design, this approach greatly reduces the piece's weight.

### "Umbrella" Collar Technology

A common nock end problem is carbon fiber fray. This is reduced significantly due to the sloped shape, an "umbrella" if you will, of the AeroBushing's crown. Further, for those hits that are not fully deflected, the 45 degree collar protects the carbon from direct impact.

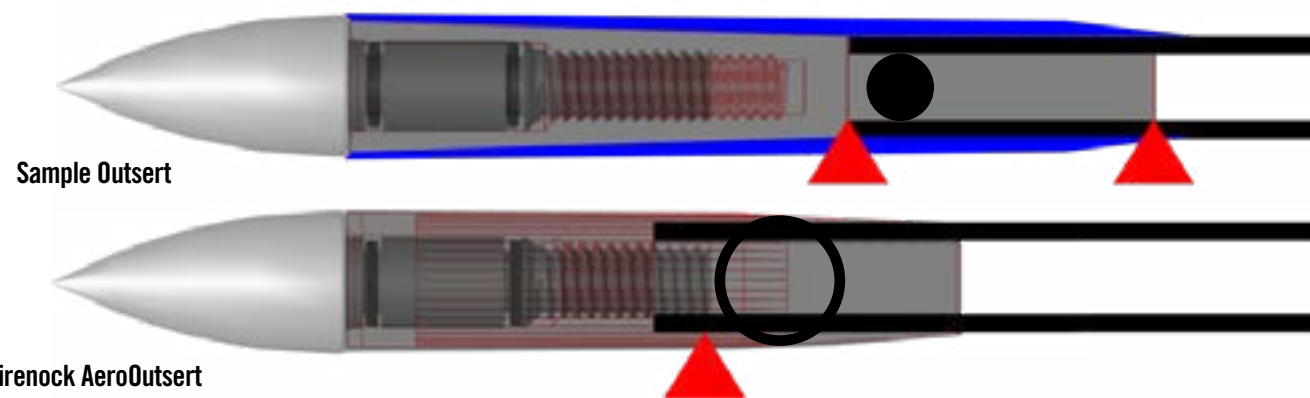

Sample Outsert

Firenock AeroOutsert

## Outserts 101

Consider the top component. It is a sample half-out insert with a familiar point installed. Now notice the red point as well as the two red triangles and all of their relative positions to each other. The red triangles are the fulcrums or pivot points of the system. Levers use rotational torque. Therefore, to evaluate mechanical leverage, one must consider the length of the effort arm. In general, the longer the effort arm, the higher the chance of bending.

A further problem is the strength of the material. Most inserts are made of aluminum and, at least at the fulcrums, solid. Take note of the diameter of the internal portion in comparison to the entire system (black circle vs outline).

This component's composition as well as its great variance in diameter, especially at its pivot points, increase its chance of bending.

What's even worse is that this solid, small rod often sits within an unevenly grinded shaft. Due to their small size, 0.166" ID shafts are notorious for unreliable wall-thicknesses. Ultra slim shafts, while nowadays fortunately rolled on mandrills for consistent IDs, their ODs are unfortunately made possible via center-less grinding.

But what about ballistic collars? Yes, while they do resolve one of the pivot or bending points, no other problems are compensated for. Collars only act as a stopgap solution.

Finally, consider the Firenock AeroOutsert (bottom component). There is only one fulcrum and the distance from that pivot point to the effort point is significantly shorter than before. Further, due to the nature of an outsert, it does not rely on wall thicknesses and remains hollow all the way through, negating all the aforementioned problems, i.e., variable diameters, partially solid composition, uneven wall-thicknesses, that could lead to bending.

The next components up for discussion are the insert and point. The most significant features of the arrow/insert/point relationship are shoulder shape and concentricity. Read on to learn why.

## Shoulders 101

Inserts have two common problems.

Due to their parallel shoulders, when a shaft is not squared evenly, a gap can form under an insert. This gap can cause the insert to slide back until, eventually, it crushes the carbon.

Even if a shaft is squared, due to how an arrow oscillates at impact, especially in a widening manner, an insert can also force an arrow to flare out or "mushroom," ultimately ruining the arrow altogether.

The Firenock AeroInsert solution ditches parallel shoulders and replace them with ones that utilize Reverse Tapered Shoulder Technology (RTST). This patented feature strengthens an arrow and ensures that carbon can never be crushed nor experience mushrooming. Note that to take full advantage of the RTST, it is essential that the shaft is chamfered before installation. An Arrow Chamfering Tool (ACT) in both 100 and 180 grit is available for purchase on our webstore.

## Concentricity 101

Another less known but still significant issue with traditional inserts is their capacity for concentricity. RTST on all AeroInserts also solves this problem.

Concentricity is the quality of having the same center. This matters in archery because weight distribution directly impacts flight and oscillation efficiency. It is crucial to store and release as much energy as possible and that can only happen if the entire system, from end to end, works as one unit. Like a funnel, via its tapered shoulder, an AeroInsert can be installed only one way and that is perfectly centered.

## F.A.C.T. for Arrow Points

If the arrow and insert are concentric, shouldn't the point be too? Firenock Arrow Concentricity Technology or F.A.C.T. is utilized on every iteration of our arrow points to ensure a perfect fit. Instead of a RTST, however, all Firenock points are equipped with two rubber O-rings—"double O-rings."

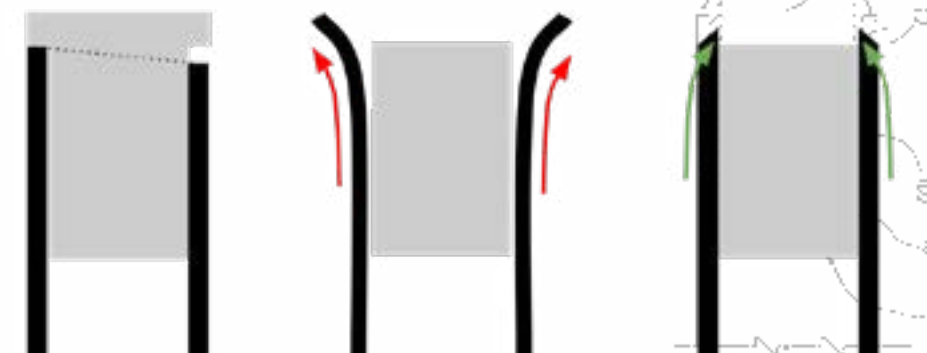

Uneven Squaring

Mushroom/Flare Out Effect

Reverse Tapered Shoulder Technology (#8403777)

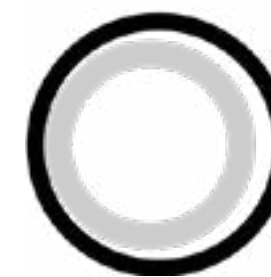

Off-Center

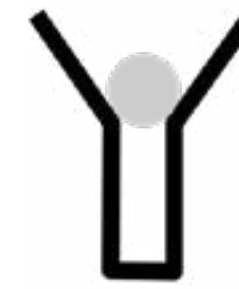

Funnel

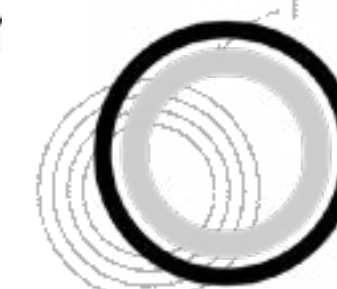

Concentric

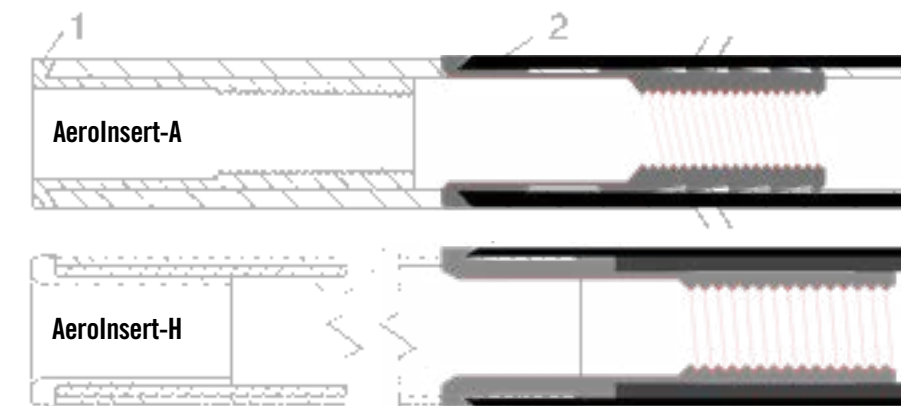

AeroInsert-A

AeroInsert-H

Destroyer Insert & Point

Firenock Arrow Concentricity Technology

Stalker Insert

# AEROCOMPONENTS *Overview*

There are over twenty patents represented within the Firenock AeroComponents. Some of them are only used for one series but many are used in several, even compounded. There are two major categories of components available from Firenock: AeroSystem (AS) and AeroConcept System (ACS). AeroSystem products include the AeroBushing, the AeroOutsert, the AeroInsert-A, the Stalker Series (Stalker AIA), and the AeroPoint. All of them plus the Firenock lighted nock system and Aerovanes are standalone products that can be incorporated into your current setup immediately. The ACS includes the AeroInsert-H, the AeroConcept Point, the Destroyer Series, and the Stalker Series (Stalker AIH). While many ACS components look very similar to those in the AS, there is one crucial difference: every one must be used with a Carbon Inner Tube, i.e., a smaller carbon shaft that is glued into a standard arrow for strengthening the frontal end as well as creating a variable spine. You'll learn more about what this means later.



# Firenock®

## OUR PROVEN ADVANTAGE

The Most Advanced Lighted Nock

Almost twenty years since its introduction, the Firenock lighted nock system is still the most advanced and versatile of its kind. There are currently 21 styles of Firenock nocks designed to fit and replace most arrows on the market. In 2018, with the addition of the “U” style nock (US Patent # USD717389), we proudly announced that we have a lighted nock system for every known crossbow bolt serving size. 2020, we further perfected our lineup with the D3 nock. This year, more aluminum “+” (pronounced “plus”) style nocks are added to the lineup.

Firenock works both with Missile-Arming Technology, which means that it lights up once fired, and with a miniaturized directional G-switch, which means that it does not require an actuator to turn on/off (US Patent # 7837580). Firenock is super durable, remaining lit after hitting hard objects (e.g., bone, stone, or concrete), after game moves vigorously, or even if it is submerged into water for weeks when equipped with a Hydro Bow-Fishing Adaptor.



The Firenock lighted nock system involves four components (see the deconstructed “S” style hunting system above)—the nock, the circuit, the battery, and the Extreme Shock End Cap. These components are interdependent and interchangeable; they work together to become the Firenock Advantage.

Our polycarbonate nocks, for example, are not only highly precise and light transmissible, but also claim a patented Shear Lock/Release System (US # D717389). Nocks shot through an animal or into the earth can be easily field replaced after circuit removal. All Firenock nock styles—C, C+, D, D+, D2, D3, F, J, J+, M, Q, Q+, S, U, U+, U+5, V, and Y; A & E; G—are compatible with all Firenock circuits—H, T & I; N & K; Z & O—respectively.

For those who don't want to shoot a lighted nock but want to benefit from the advanced design of the Firenock polycarbonate nocks, “plain” nocks in up to nine colors (red, green, clear, blue, orange, yellow, pink, smoke, and wood) are sold separately.

### METAL NOCKS (NEW FOR 2024)

The “+” or plus style nocks are based on their polycarbonate namesakes but machined from aluminum for extra durability. Today's high-speed, high-power crossbows juggle a lot of energy, and plastic nocks often suffer from the excess. Borrowing from AeroBushing, plus nocks are concentric via our patented Square in a Circle Technology. An open slot allows for circuit installation versus the standard Compression System.

The plus lineup includes six styles: C+, D+, J+, Q+, U+, and U+5. These styles' clip-on serving sizes match their namesakes. U+5, however, is specifically designed for the newer Ravin R500s with an additional 0.005” to its nock throat opening. F+ was discontinued in 2023. Metal “plain” nocks are sold in packs of three. All six styles will be ready for purchase by April 2024.

### CIRCUITS (UPDATED FOR 2024)

The FLNS core is the printed circuit board (PCB) and its G-switch, which together have a lifespan of 30,000 cycles. There are three functions in up to three sizes: Hunting (H, N, Z) stays solidly lit until deactivated; Target (T, K, O) automatically turns off 17 seconds after activation; and Blinking (I) stays solidly lit for six seconds and then blinks until deactivated. All seven series are available in six LED colors (blue, clear, green, orange, red, and yellow).

For 2024, our PCB's construction upgraded from direct bonding to modern surface mount technology (SMT) or thin small outline packaging (TSOP) explicitly. This new process allows for a more contained chip with higher reliability. Every connection wire remains 24K gold-plated, and the entire board is still hermetically sealed for EMF and UV shielding. We believe these updates will increase the already impressive survivability of the FLNS. If your circuit ever does get damaged, we offer a lifetime refresh/side-grade service (see page 2 for more details).

### CONNECTION SYSTEMS



Due to many requests for a more straightforward connection between the battery and the circuit, the dual-loop cross-lock system (above left) was replaced in 2014 by the EZ-Coil system (above center). As its name suggests, EZ-Coil allows for efficient installation and removal, involving a quick twist and a push/pull motion.

However, for the ultra-slim systems which do not have room for the EZ-Coil, i.e., “G” style, the Stack-Coil system (above right) has been standard since 2013. As its name suggests, Stack-Coil stacks each components upon each other, only remaining assembled via compression between the nock and the pre-positioned ESEC. Any twisting motion to a Stack-Coil-equipped system can short the battery and/or damage the circuit internally.

### BATTERIES

We offer two custom battery chemistries: the “BR” and the “BL” batteries. While the BR is our most powerful battery, the BL battery is more stable with a three versus one-year shelf life and 60% of the power of the BR battery. In summary,

- **BR** is the ideal winter-season battery. It can handle temperatures as low as -17°F/-27°C but no higher than 90°F/38°C. Fresh units begin shipping annually on July 1st.
- **BL** is the ideal all-year-round battery. It can handle most temperatures in the USA, from ~4°F/-20°C to 180°F/82°C.
- **BU** was the ultimate backup battery. Although BU was discontinued in 2021, vendors still have some in stock.

### EXTREME SHOCK END CAPS

Due to the design of the EZ-Coil, Extreme Shock End Caps (ESEC) are a must. Today, all styles of Firenock come with ESECs and ESEC installation tools. After years of testing, ESECs have repeatedly proven that they are the best insurance policy you can have for both standard and crossbow arrows for any speed or terms.

For those who bowfish and need Firenock to last in water for weeks instead of days, we developed the Hydro™ Bow-Fishing Adaptors to replace the ESEC. Initially released in 2007, this series includes two adaptors that mate the Firenock lighted nock system with either a 5/16” fiberglass bow-fishing arrow (Bf) or a 0.300” ID carbon bow-fishing arrow (Bfl).

### PRACTICE MATCHED WEIGHTS



For those who would like to conserve their circuits for hunting and/or competitions only, Firenock created the Practice Matched Weight Packs. Included within each pack are three green nocks (for ease of identification), three weights with the same or “matched” distribution as a Firenock circuit and battery, and three ESECs plus their O-rings (see deconstructed “S” style practice system above). No re-tuning necessary.

### CONCLUSION

With all of the above features, we at Firenock believe we have the most advanced lighted nock system. If you are looking for the finest quality lighted nocks, obtain the Firenock Advantage today.

# Packs Summary FIRENOCK®

Designed to suit every hunter or competitor's needs, the FLNS has tens of thousands of possible combinations. For convenience, three and six system packs are available in most nock styles in up to three of our most popular colors (blue, green, and red) and in up to four functions (“h” hunting, “t” target, “ht” hunting & target, and “i” blinking.) Every component is also available in separate packs to allow for complete customization.



### FIRENOCK LIGHTED NOCK SYSTEM PACKS

#### 44 Firenock Complete Systems (3/6)

A3h-B, A3h-G, A3h-R, A6ht-R, C3h-G, C3h-R, D3h-i, D3h-R, D6ht-R, D23h-R, D23i-R, D26ht-R, D23h-R, E3h-G, E3h-R, E6ht-R, F3h-G, F3h-R, G3h-G, G3h-R, G6ht-R, G6ht-G, J3i-R, J3h-R, J3h-G, J6ht-R, M3h-R, M3h-G, S3h-B, S3h-G, S3h-R, S6ht-R, Q3i-R, Q3h-R, Q3h-G, Q6ht-R, U3h-G, U3h-R, U3i-R, U6ht-R, V3h-G, V3h-R, Y3h-G, & Y3h-R

#### 57 Polycarbonate Nock Packs (7/14/100)

AB, AC, AG, AR, AY, AS, AW, CC, CG, CR, DC, DG, DR, D2C, D2G, D2R, D3C, D3G, D3R, EC, EG, ER, FC, FG, FR, GC, GG, GR, GS, GW, JC, JG, JR, MC, MG, MR, QC, QG, QR, SB, SC, SG, SO, SP, SR, SS, SY, SW, UC, UG, UO, UR, VC, VG, VR, YC, YG, & YR

#### 12 Metal “+” Nock Packs (3)

C+O, C+G, D+O, D+G, J+R, J+G, Q+R, Q+G, U+O, U+G, U+5O, U+5G

#### 42 Circuits Packs (3)

HB, HC, HG, HO, HR, HY, IB, IC, IG, IO, IR, IY, KB, KC, KG, KO, KR, KY, NB, NC, NG, NO, NR, NY, TB, TC, TG, TO, TR, TY, ZB, ZC, ZG, ZO, ZR, ZY, OB, OC, OG, OO, OR, & OY

#### 2 Battery Packs (3)

BR & BL

#### 7 Replacement O-ring Packs (7)

OAx, OB, OC, OFx, OGx, OSx, OYx

#### 6 Extreme Shock End Cap Packs (3/12/50/100)

XA, XE, XF, XG, XS, & XY

#### 15 Extreme Shock Practice Matched-Weight Packs (3)

PAx, PCx, PDx, PD2x, PD3x, PEx, PFx, PGx, PJx, PMx, PQx, PSx, PUx, PVx, & PYx

## MIX AND MATCH TO CREATE YOUR PERFECT SYSTEM



# Installation & Replacement Instructions FIRENOCK

Though every Firenock lighted nock system 3-pack and 6-pack comes with detailed, style-specific instructions, we've decided to add a general version here within our catalog. Remember that all Firenock customers are always free to contact our office for support.

## Firenock Extreme Shock End Cap Installation

1. Remove the plastic nock that comes with the arrow.
2. Remove broadhead/field point.
3. Screw the extreme shock end cap onto the tool. (Fig. 1)

**Note:** If broadhead or field point is not removed, back pressure can cause the glue to not set.

**Note:** As of 2015, every Firenock comes with an installation tool. These tools are used to install end caps. Do not over screw the end cap onto the tool because by doing so, the end cap will be installed too shallow within the shaft. We recommend a barely snug fit for easy tool removal.

4. Roll the O-ring into the groove of the end cap. (Fig. 2)
5. Clean the inside of the shaft with an acetone-soaked Q-tip, then let dry.
6. Apply a bead of super glue gel (AG0GEL recommended) to the inside surface of the shaft.
7. While the glue is still wet, insert the end cap into the arrow shaft. Push the tool until it is flush with the arrow shaft. (Fig. 3)

**Note:** The O-ring will ensure that most of the glue is pushed behind the end cap.

8. Hold the arrow nock side down for 30 seconds to ensure the glue sets around the O-ring.
9. Try to tighten the screw. If it feels finger tight, the end cap is installed properly.
10. If the end cap is still loose, repeat steps 6-9 as instructed above.
11. Unscrew the screw from the shaft. (Fig. 4)
12. Wait until glue dries before use.

**Note:** We recommend letting the glue dry overnight, as vapor from the super glue can form a film on the battery and/or the battery positive wire-holder and render both non-conductive.

13. Follow the rest of the instructions below to complete the installation of your lighted nock system.

## "S" Style Figures

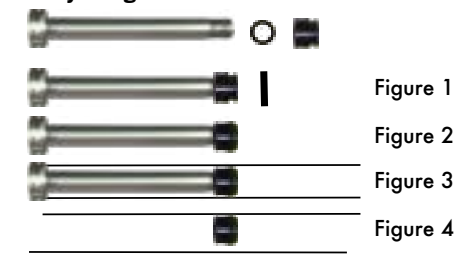

## "G" Style Figures

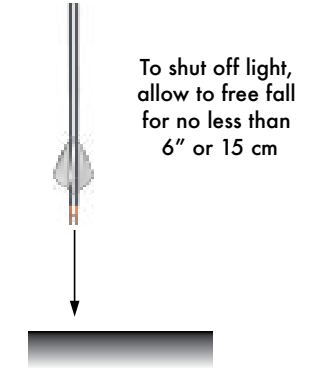
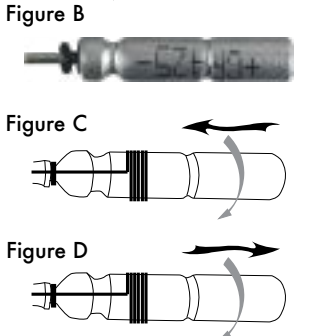
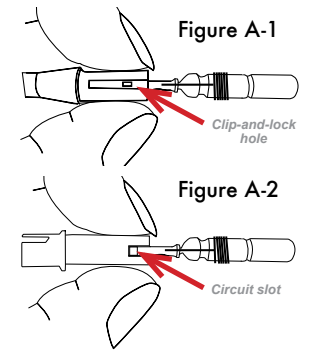
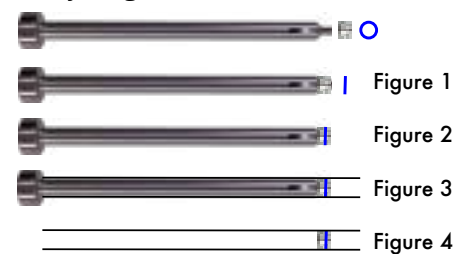

## EZ-Coil Circuit Installation (1-3) and Replacement (4-7)

1. Align the PCB (Printed Circuit Board) with the click and lock hole in the nock as shown (Fig. A-1).
2. Squeeze the nock cylinder to allow the PCB to be inserted into the nock.
3. Insert the PCB until a distinctive click is heard and/or felt.
4. Ensure the battery is and remains installed during nock replacement to avoid wire connector damage.
5. Squeeze the nock cylinder by hand as shown in Figure A-1 to release the PCB from its anchors.
6. Hold the PCB, with the battery installed, and pull it out gently from the nock.
7. Repeat step 5 and install the new PCB, LED first. See steps 1-3.

**Note:** Too much pressure on the nock during installation or removal may cause the nock to crack or break.

## "Plus" Metal Nock/Circuit Installation (1-2) & Replacement (3-5)

1. Align the PCB (Printed Circuit Board) with the slot in the nock as shown (Fig. A-2).
2. Insert the PCB until it is butts against the end of the slot.
3. The battery must remain installed during nock replacement to avoid wire connector damage.
4. Hold the PCB, with the battery installed, and pull it gently away from the nock.
5. Repeat step 4 and install the new PCB, LED first. See steps 1-2.

## EZ-Coil Battery Installation (1-2) & Replacement (3)

**Caution:** Do not allow the battery pin to come into contact with the battery wire connector.

**Note:** Battery should be removed from the PCB if not used for over 30 days or will be drained within a year.

1. Thread the battery-pin O-ring onto the pin of the battery. (Fig. B)
2. Insert the battery into the EZ-Coil with a counter clockwise action until the battery O-ring touches the battery and the pin connector on each end. (Fig. C)
3. Rotate the battery counter clockwise and gently pull the battery out and away from the EZ-Coil (Fig. D).

## EZ-Coil Firenock Lighted Nock Installation (1-3) & Removal (4)

1. Rotate and push the nock down into the shaft until it is flush to the end of the nock cylinder.
2. Align nock via the desired fletching configuration.
3. Push the nock into the shaft until flush.
4. With a firm grip, rock and gently pull the lighted nock system from the shaft.

## Stack Coil Firenock Lighted Nock Installation

1. Push the battery pin with its O-ring installed into the circuit board pin connector to form a unified unit.
2. Slide the battery with the circuit board installed down the shaft and onto the end cap.
3. Align your nock via the desired fletching configuration.
4. Push the nock into the shaft until flush.

## Stack Coil Battery Replacement

1. Remove the nock by using a twist and pull action.
2. Remove the circuit board by tapping the arrow on a hard surface, nock end first, until the LED appears.
3. Pull the circuit board out of the shaft. If the battery is not attached, tap the arrow again.
4. Follow Stack Coil Firenock Lighted Nock Installation directions above to install the nock with a new battery.

**Caution:** Using pliers with a ridged throat may cause the nock to be scratched, weakened and/or damaged.

**Caution:** Forcefully using pliers to remove the circuit board may damage the LED.

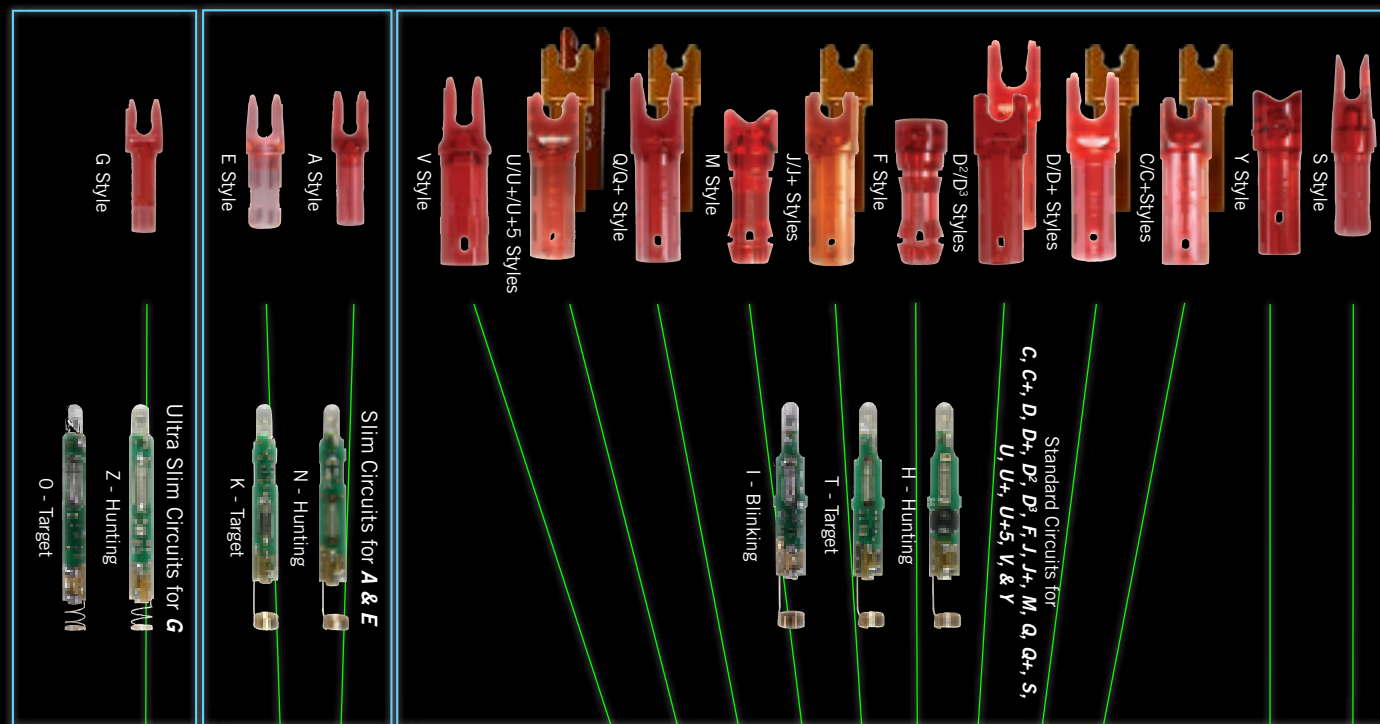

21 Styles of Firenock Nocks in up to 9 Colors

7 Series of Firenock Circuits in 6 LED Colors and up to 3 Functions

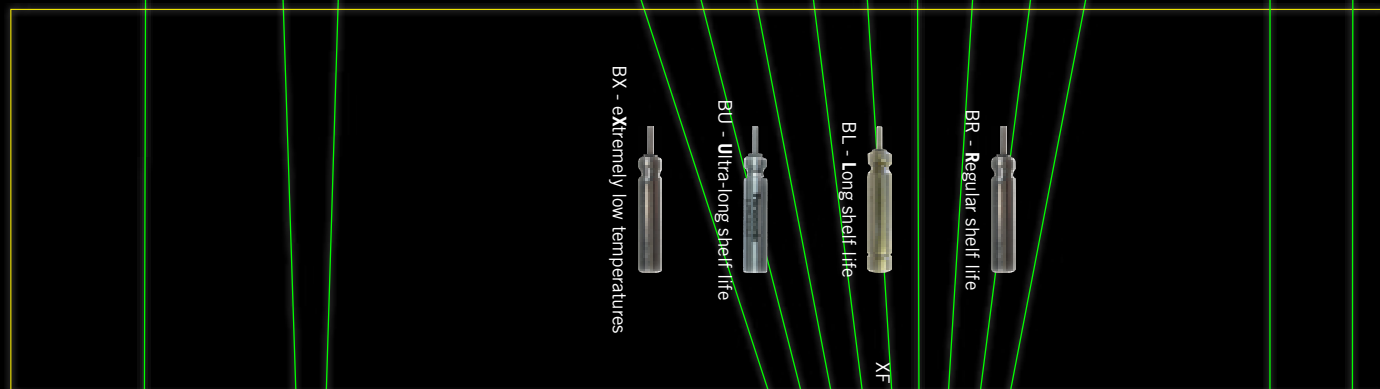

4 Battery Chemistries to Fit All Firenock

Extreme Shock End Cap Installation Tools

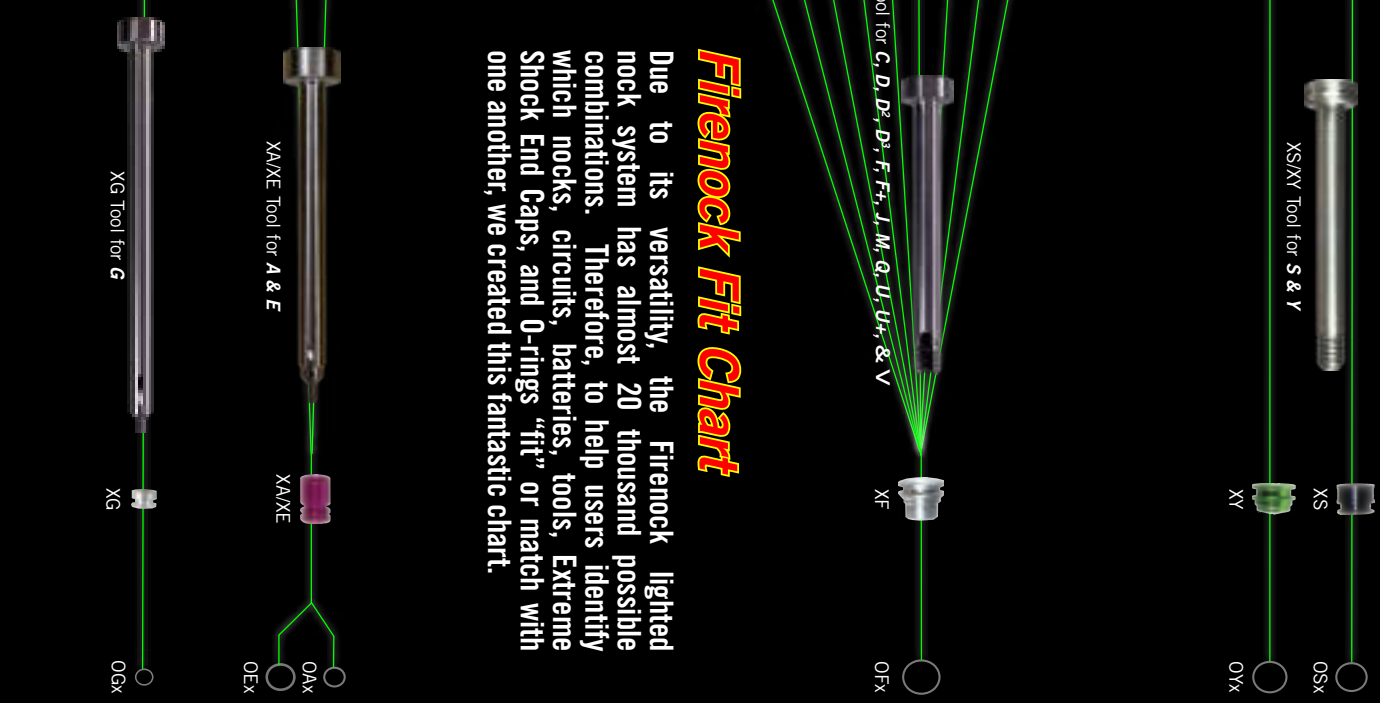

ESEC O-rings

**Firenock Fit Chart**  
Due to its versatility, the Firenock lighted nock system has almost 20 thousand possible combinations. Therefore, to help users identify which nocks, circuits, batteries, tools, Extreme Shock End Caps, and O-rings "fit" or match with one another, we created this fantastic chart.

# AEROVANE® II A New Spin on Arrow Flight

Aerovane is the first and only vane to employ Airfoil Technology (US Patent # 8105189) for archery arrows. Aerovane does not look like and does not work like traditional vanes. It is not flat, it is not smooth, and it does not use drag. Read on to learn what it IS instead and why.

## Development

When the first Aerovane (Aerovane I) was introduced in the spring of 2008, a lot about the connection between aerodynamics and arrow dynamics was not fully understood. For example, Aerovane's surface was designed as smooth as possible in an attempt to decrease friction. However, we soon discovered that a smooth surface does the opposite—it increases frictional air drag. In over our heads, we consulted the aerospace engineering expert, Dr. Michael Selig of the University of Illinois at Urbana-Champaign (UIUC). Afterward, Aerovane II was born.

## Slim Rectangular Pyramid

Before getting into texture, it's important to mention the main design feature that did work in the Aerovane I: the pyramid. Aerovane has never been flat. Consider a normal piece of paper versus a paper airplane. While a piece of paper won't go too far when you throw it, a paper airplane's wings will catch air and fly. That is why Aerovane was and will always be a three-dimensional pyramid.

Aerovane, however, does not have sharp angles like a normal pyramid. It's edges are curved to reduce sound. Specifically, its frontal curvature is inspired by an owl, the only bird on earth that flies in complete silence.

## Regional Texture Zones

Under Professor's Selig's counsel, the Aerovane II and Aerovane 3 feature regional texture zones.



Examine the two sample surfaces above. If you had to step on one of these surfaces, which would you choose? Most would select the bottom one because it has more points to distribute weight e.g., bed of nails. However, this is not the correct answer in fluid dynamics.

Air is fluid. Although air is not weightless, its weight is so insignificant it is negligible. Instead, because it cannot distribute its own weight, air creates cushions for itself on surfaces with rougher textures (rougher, at least, at a micro level). Via these Surface Boundary Layers, the texture zones actually help guide the air along.



Due to the curved, pyramid-like shape of the Aerovane, the path in which air passes over it is also curved. Air must run up and down the curve. But because air wants to take the shortest path possible, texturing brings the air towards the vane itself and overall minimizes turbulence. Notice the color-coded vanes on the other page. For Aerovane II, the roughest texture (yellow) is on the far right and continues to the smoothest (left, blue).

Aerovane 3 takes this farther via dynamic texturing. By segmenting the zones more intentionally, air flow is optimized and any residual negative effects are reduced. The winglet is given the roughest texture to guide the air flow along the upper third.

## Drag versus Circular Lift

Unlike every other vane on the market, Aerovane does not use drag. Flight is fundamentally a process of deceleration. This is due to drag. Without drag (and gravity, of course,) objects in flight would stay in flight forever. Drag, then, is an opposing force and it only increases as speed does, to the point that it wastes energy.

Aerovanes, however, use lift instead of drag. Specifically, they utilize Airfoil Technology to maintain energy throughout flight.

By definition, an airfoil is a structure with a curved surface that takes advantage of Bernoulli's Principle. This principle states that an increase of speed occurs simultaneously with a decrease of pressure. But what does that mean and why does it matter? Consider the next diagram.

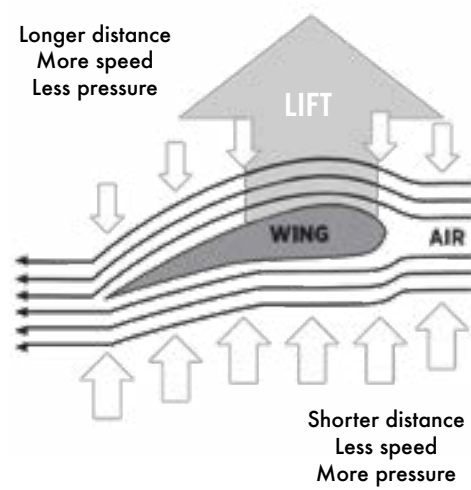

There is air flowing over and under the structure named "wing." Due to the wing's shape, the air above must travel farther and therefore faster, exerting less pressure. The opposite is the case for the air below—it must travel a shorter distance and therefore can travel slower, but as a consequence exerts more pressure. This imbalance in pressure creates lift.

But that's just one wing. For arrows, usually, there are three vanes and therefore, if Aerovane-equipped, three wings. And together, the three separate lift forces create circular lift.

Further, as an aftereffect of our reliance on circular lift instead of drag, the crosswind signature of an Aerovane-equipped arrow is exponentially smaller than usual. High crosswinds have a minimal effect on arrow trajectory.

## Conclusion

Aerovane is not like any other vane on the market. Aerovane is not flat but curved and shaped like a slim rectangular pyramid, is not smooth but features regional texture zones, and does not use drag but is equipped with patented Airfoil Technology to take advantage of circular lift. Fletched with Aerovane, your archery projectile will fly flatter, straighter, and more accurately as well as quietly. You can shoot Aerovane with confidence.

# Another Flight Revolution AEROVANE 3

The best way to illustrate relationships is, of course, with direct comparisons. Below, we've summarized the similarities and differences between the Aerovane II and the Aerovane 3. Take note that the features and characteristics mentioned are discussed in more detail on the previous page. Also, we've included a full Aerovane fletching procedure at the lower half.



## Aerovane II

More rigid for broadhead control  
12mm or 0.55" tall  
0.42 grams or 6.48 grains  
Custom airfoils  
Three texture zones  
Minimum 260fps  
1.25" crosswind signature  
Lift efficiency of ~72k Reynolds

## Compatible Broadheads

- Bloodsport Wraith™ Deep Cut
- Firenock Dagger Series, Stalker Dagger Series, SwingBlade Series, Stalker SwingBlade Series, Traumahawk
- Muzzy Trocar
- NAP Braxe, Nightmare, Spitfire Edge, Spitfire Maxx, Thunderhead Edge, Thunderhead Razor
- QAD Exodus ("Swept Model" only)
- Rage Extreme & Hypodermic
- Ramcat All broadheads (≤1 3/8" cut)
- Slick Trick 100 & 125
- Trophy Ridge Meat Seeker 3 Blade



## Aerovane 3

Less rigid for optimized AEM  
10mm or 0.393" tall  
0.336 grams or 5.18 grains  
Custom airfoils with winglets  
Three plus one texture zones  
Minimum 270fps  
1" crosswind signature  
Lift efficiency of ~120k Reynolds

## Compatible Broadheads

- Firenock See AV2 list
- Hartcraft Trophy I
- Ramcat SBG 1"
- Slick Trick 100 & 125

## Aerovane II & 3

92D plastic  
50mm or 1.967" long  
Same aspect ratio as an owl's wing  
Slim rectangular pyramid design  
Available in 12 colors

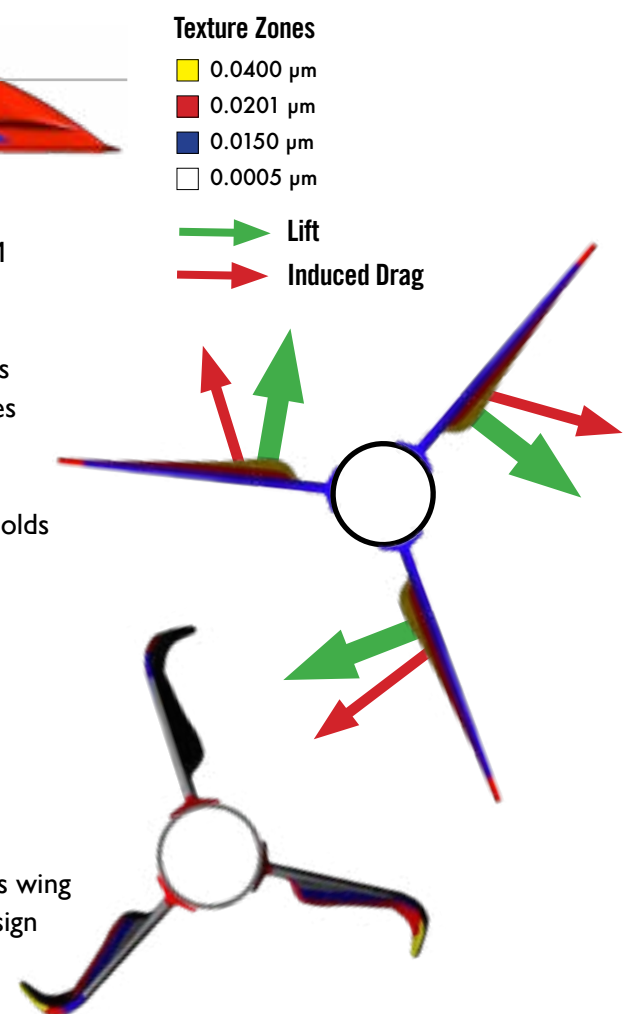

## Aerovane Fletching Procedure

### Materials

- Aerovanes
- Arrow shaft(s)
- Aerovane Jig
- Aerovane Clamp
- Super glue
- 100% acetone
- 2 x 125ml bottles
- 1 x 50ml bottle
- Cotton Q-Tips
- Paper towels

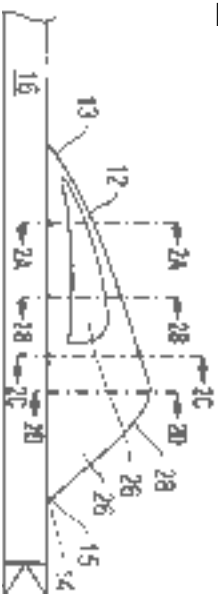

### Procedure

1. Swirl arrow shaft to loosen particles and dissolve all possible contaminants in one big acetone bottle.  
*Optional: Clean the arrow twice with two separate big bottles of acetone. Make sure to differentiate them as "dirty" (first wash) and "clean" (second wash).*
2. Wipe with paper towel and let air dry.
3. If the arrow was PAPS-indexed, make sure to match the marked index line with the machined one on the Aerovane Jig.
4. Dip a Q-Tip into the small acetone bottle then wipe the vane base from one end to the other.
5. Immediately flip the Q-Tip over and dry the vane base, making sure to swipe in the same direction as before.
6. Apply a small amount of glue along the center of the entire length of the vane base.
7. Place the clamp against the inner wall of the jig just above the chuck connection.
8. Slowly lower the clamp until the jig magnets grab hold of the clamp.
9. Firmly push the clamp down onto the arrow for nine to ten seconds (both AG0600 and AG0600's wait time).
10. Open the clamp, rotate the index counter-clockwise, and then pull the clamp directly upwards to remove it from the jig
11. Repeat steps 3-10 for the next vane.



AeroPoints, although a part of the AeroSystem line, are also an essential part of the AeroConcept System line. Every one of our twenty-six AeroPoints (four Destroyer Series not shown, on other page), equipped with Firenock Arrow Concentric Technology (FACT), are still fantastic additions to any system.

## 8mm (For Vertical Bow Arrows)



- AP0458
- AP0558
- AP0658
- AP0758
- AP0858
- AP1008
- AP1258
- AP1508
- AP1758
- AP2008

Most archers know aligning a field point or a broadhead and an arrow perfectly is near impossible because the neck and/or threads of a point often aren't concentric. A hopeful mindset of "good enough" and "acceptable" is adopted. With our Double O-ring System (FACT) (US Patent # 8337341) featured in every AeroPoint, such difficulties and attitudes are a thing of the past. With specifically positioned O-rings just above the threads and at slightly under the neck of the arrow point (FACT 2.0), the installation process is effortless and flawless every time. Further, with every shot, just like the rest of our AeroSystem components, your field point will only lock itself deeper into place.

The AeroPoint Series is available in two size classes, 8mm for vertical bows and 9mm for crossbow. The prior class comes in nine weights, from 45 to 175 grains while the latter comes in ten plus one, from 45 to 250. Note that the "plus one" is our sole titanium field point designed specifically for those who want length but not the weight.

### Additional Notes

Like all Firenock products, all AeroPoints have been assigned a unique six character code for help in identification. "AP," the first two characters, represent the capital letters in "AeroPoint." The next three stand for the grain weight (e.g. 045-250). Finally, the last character represents something Firenock exclusive. Our points come in three insert contact point diameters—6mm, 8mm and 9mm. These diameters are based on the width required for a point to sit flush with a compatible insert (note the head end of the AP1758, for example).

## 9mm (For Crossbow / Target Arrows)



- APT459\*
- AP0459
- AP0559
- AP0659
- AP0759
- AP0859
- AP1009
- AP1259
- AP1509
- AP1759
- AP2009
- AP2509

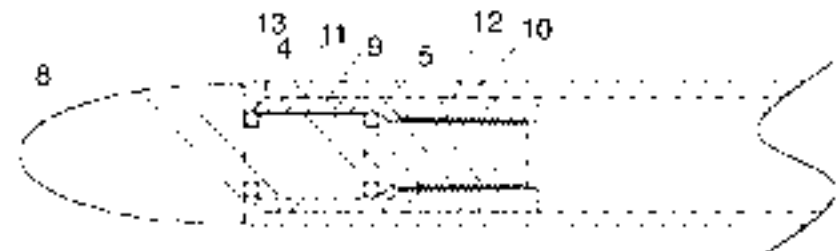
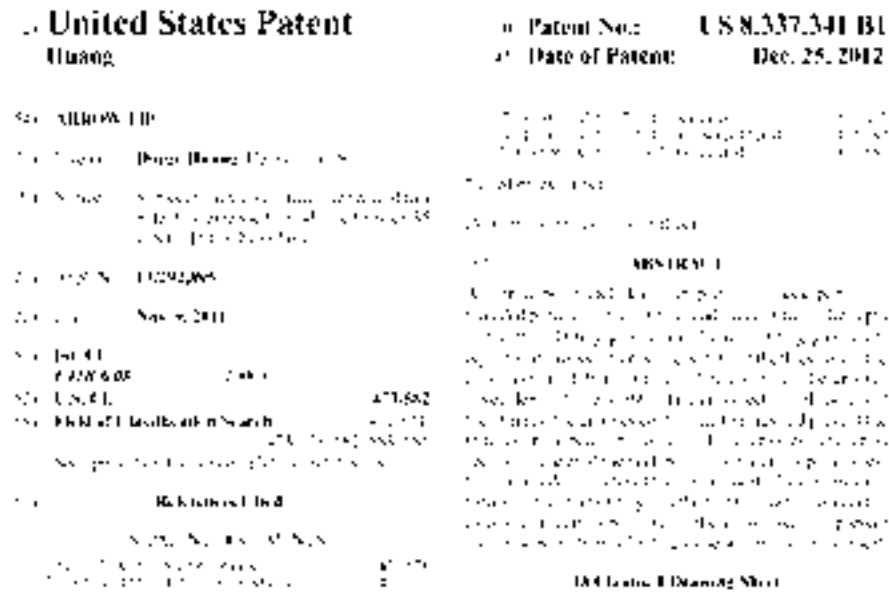

While there are currently two types of AeroInsert\*, only one is a part of the AeroSystem line—AeroInsert-A (AIA). Although not compatible with the AeroConcept System, AIA's design and characteristics are not only essential to its counterpart, the AeroInsert-H, but make the product itself a great standalone component for those who prefer a straightforward system.



- AIA20A
- AIA20S
- AIA20T
- NEW!** AIA20S4
- NEW!** AIA20T4
- AIA23A
- AIA23S
- AIA24A
- AIA24B
- AIA24C
- AIA24S
- AIA30B
- AIA30S
- AIA3MB
- AIA3MS
- AIA32A

Code	Compatible Shaft ID	Max Compatible Shaft OD	Weight	Material	Price/dz	Finish
AIA28A	0.202" - 0.204"	7.20 mm	~ 22 gn	7075-T5 AL	\$19.95	Black Anodized
AIA28S	0.202" - 0.204"	7.20 mm	~ 55 gn	420 SS 53 HRC	\$39.95	Natural
AIA28T	0.202" - 0.204"	7.20 mm	~ 33 gn	GR5 Ti	\$69.95	Natural
AIA28S4	0.204" - 0.207"	7.20 mm	~ 55 gn	420 SS 53 HRC	\$39.95	Natural
AIA28T4	0.204" - 0.207"	7.20 mm	~ 33 gn	GR5 Ti	\$69.95	Natural
AIA23A	0.228" - 0.230"	7.29 mm	~ 13 gn	7075-T5 AL	\$19.95	Natural
AIA23S	0.225" - 0.230"	7.29 mm	~ 31 gn	303 SS	\$39.95	Natural
AIA24A	0.242" - 0.246"	7.85 mm	~ 11 gn	7075-T5 AL	\$19.95	Natural
AIA24B	0.242" - 0.246"	7.85 mm	~ 32 gn	Brass	\$14.95	Natural
AIA24C	0.242" - 0.246"	7.85 mm	~ 11 gn	6061-T6 AL	\$14.95	Natural
AIA24S	0.242" - 0.246"	7.85 mm	~ 30 gn	303 SS	\$39.95	Natural
AIA30B	0.299" - 0.300"	8.89 mm	~ 85 gn	Brass	\$39.95	Natural
AIA30S	0.299" - 0.300"	8.89 mm	~ 90 gn	303 SS	\$39.95	Natural

AeroInsert-A boasts Reverse Tapered Shoulder Technology (US Patent: 8,403,777).

What does such a technology entail? First, consider the name. On any insert, whether it's standard or a half-out, a portion remains outside the arrow. We call that portion a "shoulder," which most significant part is where it meets with the front of a shaft. For after repeated use, any disparity in pressure at that contact point can cause mushrooming and/or splintering. There are two main reasons for these outcomes [1] inconsistent insert and/or shaft sizing (i.e. if one is narrower or wider than the other, pressure can be distributed incorrectly) and [2] uneven squaring (i.e. if both are not perfectly square, one or both can shift around and, again, distribute pressure irregularly). And, unfortunately, no matter how closely matched the sizing or how thorough the squaring, arrow failure has proven inevitable.

But what if those causes could never come into effect in the first place? What if, instead of trying to avoid their causes, they could be used as an advantage? With Reverse Tapered Shoulder Technology, such is a reality. By simply preparing an arrow with a 45 degree chamfering (see our recommended Arrow Chamfering Tool below), an AeroInsert-A with a reverse 45 degree tapering can mate with it. Repeated use will only benefit concentricity—as energy and pressure from launch and/or impact transfer(s) the arrow sits and locks deeper into the insert. Ultimately, sizing no longer matters past ID and squaring is no longer necessary since AIA requires chamfered shafts instead.

\*AeroInsert-D (AID) inserts have been discontinued and replaced by AeroInsert-H.



### The Arrow Chamfering Tool

This custom tool creates a perfect 45 degree chamfering to the end of an arrow to mate with the Reverse Tapered Shoulder of an AeroInsert-A or an AeroInsert-H. The ACT is made of steel and its grinding surface is diamond electro-plated. It's extremely easy to use. Simply attach it to any drill, place your arrow at the center of the tool and run the drill (~1500 rpm) for approximately three seconds. Immediately after, your arrow is ready for any components. To clean, just throw it in the dishwasher, dry, and it is ready to be used again. Available in 100 grit and 180 grit.

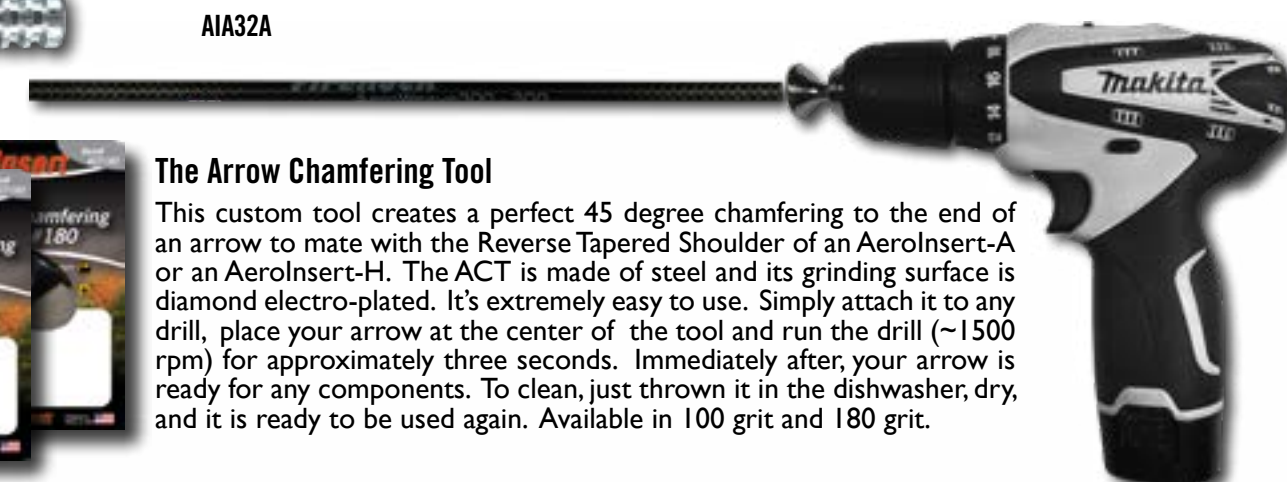

# AEROCONCEPT SYSTEM™



## ACS Version 1.0

The AeroConcept System (ACS) involves four elements, three of which are familiar to most—an arrow shaft, an insert, and a point (see diagram above). The last element of the ACS, unique to Firenock, is a “Carbon Inner Tube” (see next page). This tube, as suggested, is made of carbon and is intended to sit within an arrow shaft. Specifically, its designed for installation with an AeroInsert-H (see next page) to create one large insert unit. The question still remains however, why include this Carbon Inner Tube? Well, the AeroConcept System, via this extra element, will not only strengthen your arrow’s front end, but also gives your arrow a variable spine (i.e. spine at the front and at the back are different). The first effect’s cause is obvious. By adding—i.e. gluing with the intention of melding—a new, smaller carbon tube into your shaft, the overall wall thickness increases at the front, stiffening and generally reinforcing it. The reason for the second effect, the variable spine, is a bit trickier. To explain, first recall the oscillation cycle of a standard arrow from the AeroFlight 101 spread. Now, realize that due to the addition of the CTI, the spine is higher near the front than everywhere else. This distinction means that the radius of that oscillation is shortened significantly (see illustration below). And due to that shorter radius, the cycle of oscillation is dampened—in fact, harmonically dampened (US Patent # 9395166). Your arrow stops flexing significantly faster and thus begins flying flat faster. With your arrow equipped with the AeroConcept System and Aerovane II or III, it can even enter a gyro spin.

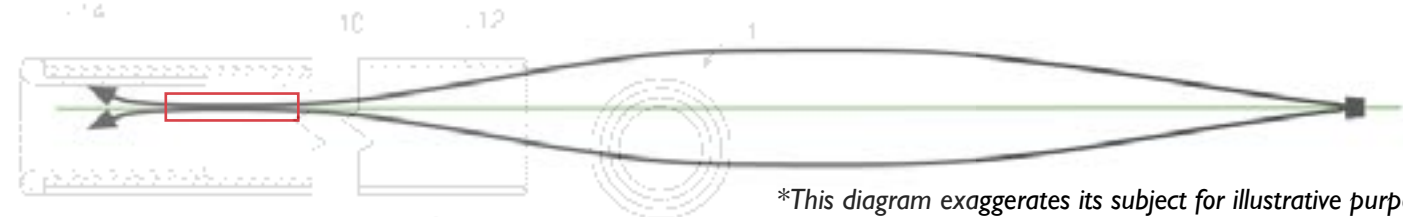

Additionally, an aftereffect of the AeroConcept System is how it extends a node into something we call a “null zone” (marked above in red). This shift allows for more arrow forgiveness since there’s an actual entire area to accurately position your arrow rest at pull back instead of a singular point. Learn more about why this matters from the AeroFlight 101 spread.



## ACS Version 2.0

The AeroConcept System 2.0 (ACS2), introduced in 2018, involves all four elements of the ACS but with the supplement of another Carbon Inner Tube at the back of an arrow behind the nock or Firenock lighted nock system (US Patent # 10232581). To understand the benefits of the ACS2, just imagine those of the ACS and then amplify them by 30-40%. The aforementioned radius of oscillation is even smaller (see illustration below), allowing for further energy retention. An arrow equipped with ACS2 will fly yet flatter and therefore with an even higher POI (point of impact).

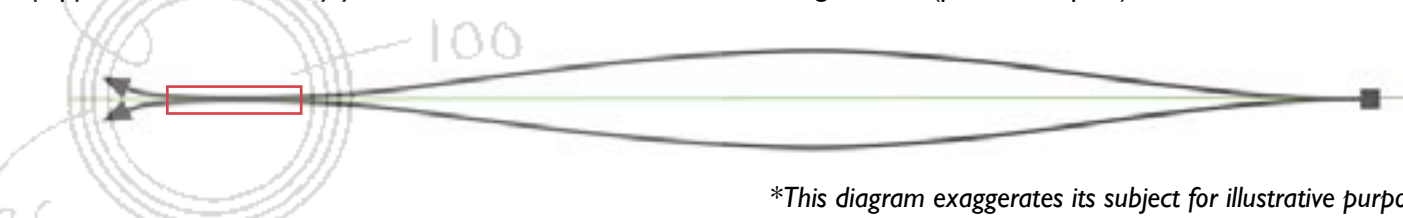

# CTI & AeroInsert-H AEROCONCEPT SYSTEM



Highly modular, Firenock Carbon Inner Tubes are engineered to perfectly mate with AeroInsert-H to form the AeroConcept System. The AeroConcept System strengthens and stiffens (i.e. increases the spine) (an) end(s) of your arrow without adding too much weight to the entire shaft. An inner tube transforms your arrow, making it an arrow with a variable spine, promoting the initiation of harmonic dampening leading to oscillation cancellation, i.e., your arrow’s amount of flexing cycles reduces and begins to fly straight faster). Furthermore, though they are pre-cut at six inches, you can cut down a Carbon Inner Tube’s length to precisely adjust the weight of your entire arrow.

Code	for Arrow ID	Weight	Compatible Components	Compatible Arrows
CT1166	0.165" - 0.1665"	~ 3	SA005, SH005, AOA (AeroOutsert)	AeroWeave166, BE Deep Impact, GT Pierce
CT1200	0.202" - 0.204"	~ 7.7	AIH20A/S/T	AeroWeave204(L), BE Rampage, Easton Axis FMJ
CT120L	0.202" - 0.204"	~ 4	AIH21A/S/T, AIH21A/L4/T4	AeroWeave204(L), BE Rampage, Easton Axis FMJ
CT1240	0.242" - 0.246"	~ 5.2	AIH24A/B/C/S	AeroWeave246, BE Carnivore, GT Pro Hunter
CT1300	0.300"	~ 8.5	AIH30A/B/C/S, AIH3MS	AeroBolt, BE Executioner, GT Laser III
CT130L	0.300"	~ 7	AIH31A/B/C/S, AIH3HS, AIH3GS, ACP30S	AeroBolt, BE Executioner, GT Laser III
CT1310	0.315" - 0.318"	~ 5.9	AIH31A, ADH31A, ACP31S	AeroWeave315, BE PS23, CX OX, Easton FatBoy, Element Rock
CT1320	0.320" - 0.322"	~ 5.8	AIH32A, ACP32S	Easton Super Drive 23, GT 9.3L

AeroInsert-H (AIH) is our insert for the AeroConcept System. Loaded not only with Reverse Tapered Technology (US Patent # 8403777) from AeroInsert-A which improves arrow self-concentricity, but also Double Shoulder Technology (US Patent # 8337342) from the now discontinued AeroInsert-D, AeroInsert-H is truly the best of both worlds; “H” for hybrid.

To clarify, in this instance, a “shoulder” is a large indented surface. For Double Shoulder Technology, the first shoulder is designed to address the issue commonly found in other inserts—not enough adhesive space. Small adhesive surfaces can cause an insert to easily dislodge itself from an arrow and consequently force the insert and arrow tip to move rearward and mushroom. The second shoulder (hence “double shoulder”) is designed to perfectly mate with a smaller ID carbon shaft (i.e. Carbon Inner Tubes) to form the AeroConcept System (US Patent # 9395166). Further, with a Carbon Inner Tube, your adhesive surface increases exponentially to allow for a stronger, more secure connection.

Code	Compatible Shaft ID	Associated CTI	Weight	Material	Price / dz	Finish
AIH20A	0.202" - 0.207"	CT1200	~18 gn	7075-T5 AL	\$19.95	Natural
AIH20S	0.202" - 0.207"	CT1200	~55 gn	303 Stainless	\$39.95	Natural
AIH20T	0.202" - 0.207"	CT1200	~28 gn	GR5 Titanium	\$69.95	Natural
AIH21A	0.202" - 0.204"	CT120L	~23 gn	7075-T5 AL	\$19.95	Black Anodized
AIH21S	0.202" - 0.204"	CT120L	~63 gn	303 Stainless	\$39.95	Natural
AIH21T	0.202" - 0.204"	CT120L	~33 gn	GR5 Titanium	\$69.95	Natural
AIH21A4	0.204" - 0.207"	CT120L	~19 gn	7075-T5 AL	\$19.95	Black Anodized
AIH21S4	0.204" - 0.207"	CT120L	~50 gn	303 Stainless	\$39.95	Natural
AIH21T4	0.204" - 0.207"	CT120L	~30 gn	GR5 Titanium	\$69.95	Natural
AIH24A	0.244" - 0.246"	CT1240	~ 19 gn	7075-T5 AL	\$19.95	Natural
AIH24B	0.244" - 0.246"	CT1240	~ 30 gn	Brass	\$14.95	Natural
AIH24C	0.244" - 0.246"	CT1240	~ 19 gn	6061-T6 AL	\$14.95	Natural
AIH24S	0.244" - 0.246"	CT1240	~ 28 gn	303 Stainless	\$39.95	Natural
AIH30A	0.300"	CT1300	~ 18 gn	7075-T5 AL	\$19.95	Natural
AIH30B	0.300"	CT1300	~ 57 gn	Brass	\$14.95	Natural
AIH30C	0.300"	CT1300	~ 18 gn	6061-T6 AL	\$14.95	Natural
AIH30S	0.300"	CT1300	~ 55 gn	303 Stainless	\$39.95	Natural
AIH30MS	0.300"	CT1300	~ 100 gn	303 Stainless	\$39.95	Natural
AIH31A	0.300"	CT130L	~ 18 gn	7075-T5 AL	\$19.95	Natural
AIH31B	0.300"	CT130L	~ 55 gn	Brass	\$14.95	Natural
AIH31C	0.300"	CT130L	~ 18 gn	6061-T6 AL	\$14.95	Natural
AIH31S	0.300"	CT130L	~ 50 gn	303 Stainless	\$39.95	Natural
AIH31HS	0.300"	CT130L	~ 75 gn	303 Stainless	\$39.95	Natural
AIH31GS	0.300"	CT130L	~ 100 gn	303 Stainless	\$39.95	Natural
AIH31A	0.315"	CT1310	~21 gn	7075-T5 AL	\$19.95	Natural
AIH32A	0.320"	CT1320	~ 22 gn	7075-T5 AL	\$19.95	Natural



# AEROCONCEPT POINTS



Indeed hollow in structure, the AeroConcept Point's (US Patent # 9441927) unique paradox of strength and lightness takes a standard glue-in point to another level.

The AeroConcept Point (ACP) is a fusion of the original AeroInsert and AeroPoint. As a descendant of the AeroInsert-H, ACP features the same benefits—Reverse Tapered Shoulder Technology which assists in self-concentricity and Double Shoulder Technology which allows the point to mate immediately with a Carbon Inner Tube to form the AeroConcept System, excluding the AeroInsert and its weight from the equation entirely for those who prefer minimum frontal weight. Note that, because the ACP has a reverse taper, it must be chamfered first (we recommend the use of the Arrow Chamfering Tool).

Current AeroConcept Points weigh about 50-55 grain and are available in two sizes to fit either shafts with a 0.300" ID or a 0.315" ID. See the previous page for lists of popular arrows with these IDs.

## AeroConcept Points 2.0

Just in case you haven't noticed, ACPs are not normal glue-in points. This is only proven more true by ACP2. Although our original standard AeroConcept Points (1.0) are now discontinued, the AeroConcept 2.0 has been and is a great replacement. Equipped not only all the same technologies aforementioned, ACP2 is also designed to add variable weight. With the use of an AeroConcept Point Weight (available in 10, 20, 30, 40 or 50 grains), you can choose exactly how much weight you want at the front of your arrow. Additionally, ACP Weights boast a technology similar to FACT (Double O-ring system) for concentricity and a more secure installation.

Code	Compatible Shaft ID	Associated CTI	Weight	Material	Finish	Price/Dz
ACP30S	0.300"	CTI30L	~40gn	420 SS Harden	Natural	\$39.95
ACP31S	0.315"	CTI310	~50gn	420 SS Harden	Natural	\$39.95

fits 0.300" ID



fits all AeroConcept Point sizes



fits 0.315" ID



NEW!



## AeroConcept Point Weight Installation Tool Set (ACPWTL)

Note that ACP Weights must be installed via our custom tool set. This set involves two attachments that link a 1/4" Hex driver to a 0.166" arrow shaft for easily adding or switching out different weights into the already installed point itself.

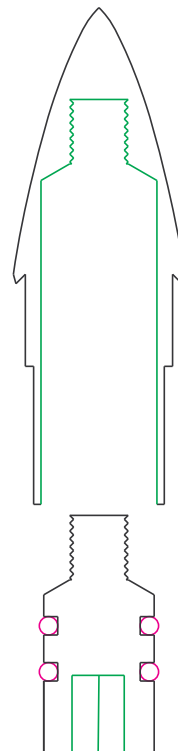

# Inserts & Points DESTROYER SERIES

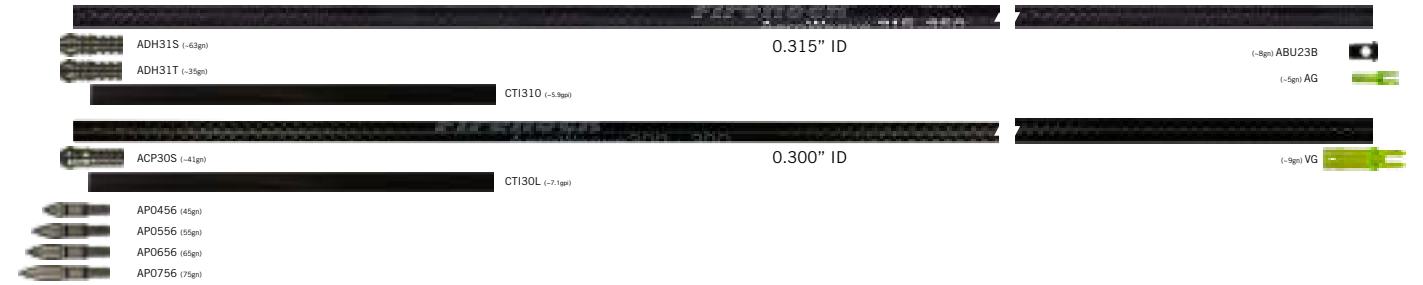

Loaded with every technology available for AeroInserts and AeroPoints used so far, the Destroyer Series components meet the challenge of the harsh environment of Hunter and Pro Class 3D competitions head on.

In total, there are three patents represented in the Destroyer Series. Starting with the AeroInserts, there are two technologies included in its design. Boasting the same technologies as the AeroInsert-H, Reverse Tapered Technology (US Patent # 8403777) and Double Shoulder Technology (US Patent # 8337342), the Destroyer AeroInserts are also equipped with a forward 40 degree angle (marked in green) to perfectly mate with its AeroPoint counterpart which shoulder is at a reverse 40 degree angle (marked in blue). Additionally, the AeroPoints utilize the same FACT (US Patent # 8337341) Double O-ring System as all our other AeroPoints.

Past all the awesome advantages packed into these components, we ensured that the Destroyer Series would be compatible with the AeroConcept System. With the installation of either the CTI300 (for 300" ID) or the CTI310 (for 315" ID) respectively, you can additionally experience the power of harmonic cancellation, shaft oscillation reduction, as well as a stronger frontal end.

## Specifications

Currently offered components are built to fit either shafts with a 0.300" ID or a 0.315" ID. Examples of popular arrows with a 0.300" ID include Firenock AeroWeave300 or SportWeave300 and Gold Tip 22 Series. Examples of popular arrows with a 0.315" ID include the Black Eagle PS23 or Challenger, the Carbon-Express CXL, the Element Rock, or the Easton Fatboy (note that the Easton SuperDrive 23 and the Gold Tip 9.3 are not included in this list because they have a 0.320" ID). Firenock Destroyer AeroInserts are available in stainless steel and titanium. Destroyer AeroPoints, on the other hand, are only available in stainless steel and have an outer diameter of 6 mm. In terms of weight, our these four points come in 45 to 75 grains.

Code	Compatible Shaft ID	Associated CTI	Weight	Material	Finish	Price/Dz
ADH30S Destroyer™	0.300"	CTI30L	~55gn	420 SS	Natural	\$39.95
ADH31S Destroyer™	0.315"	CTI310	~62gn	303 Stainless	Natural	\$39.95
ADH31T Destroyer™	0.315"	CTI310	~35gn	GR5 Titanium	Natural	\$69.95

fits all Destroyer Series insert sizes



fits 0.300" ID



fits 0.315" ID

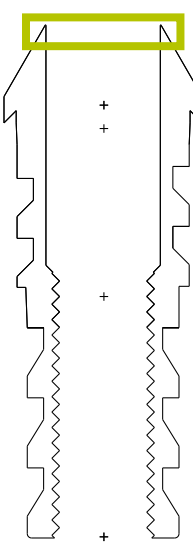
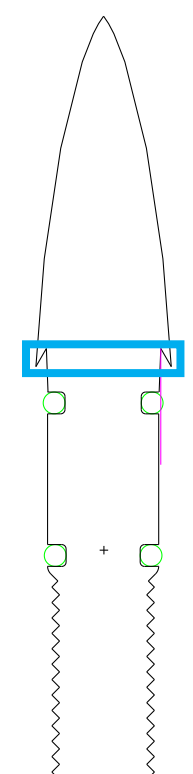

The initial objective we had when making Aerobolt was to address the issue of the weak frontal end commonly found in high speed crossbow arrows. In 2009, we built Aerobolt I using common off-the-shelf components and while it performed well, we found that common off-the-shelf components had concentricity issues and also had fundamental design issues. Aerobolt I was good but we knew it wasn't great. With more time, research, testing, and the introduction of the Firenock AeroConcept System (ACS), Aerobolt II & III are not only built to overcome the afore issues, but with stronger front ends than ever before. We believe that the Aerobolt series is one of the best crossbow arrows available for today's archers.

Most people will find that many crossbow bolts perform decently well. But why are AeroBolt better than other crossbow arrows? Why is the price of AeroBolt significantly higher? To provide these answers, a short review of the development of AeroBolt is needed. Then, we will discuss the design approach and review the technologies that have been employed in the development of AeroBolt. With this information, we believe you will be convinced that AeroBolts are unique and worth the price.

### The History of Harmonic Dampening

If asked for the main reason why AeroBolt Technology is so superior in performance and accuracy when compared to any other crossbow arrows, our answer would be because of its capacity for harmonic dampening. Harmonic dampening was observed when the first AeroBolt was shot in 2010. After only about five to ten feet, the oscillation of the AeroBolt stopped, which contrasted then and still contrasts with the standard minimum 15-18 yards it takes other arrows to cease oscillating. How could that be? The only difference between our AeroBolts and other crossbow arrows was our inclusion of a Carbon Inner Tube (CTI), which we (back then at least) only included to stiffen and strengthen the front end of a shaft. No archery experts could provide a definite answer. We finally received an answer after consulting material science/physics experts. We had discovered what is now the basis of our patented AeroConcept System.

### Preparing the Shafts

With our discovery of the true effect of a Carbon Inner Tube (CTI), we delved into research and testing. Now, for every AeroBolt, the first thing we do is cut the main arrow shaft and its corresponding CTI according to pre-determined, meticulously calculated specifications.

Next, we chamfer the front end of the main shaft with our Arrow Chamfering Tool and a drill. With transport and handling, the shaft and CTI can become dirty. To start afresh, we ultrasound clean them. After, we square the CTI with our APS.

We chamfer the main shaft and then square the CTI to take advantage of all the awesome design features of our AeroInsert-H. See, like most products in the Firenock line up, each insert series has grown and evolved over time. In the instance of the AeroInsert Series, we have had three generations of inserts: AeroInsert-A (AIA), AeroInsert-D (AID), and AeroInsert-H (AIH) respectively. AIA boasts Self-Concentric Technology while AID, now discontinued, boasted Double Shoulder Technology. AIH unites and takes advantage of the technologies from both prior inserts. And, due especially to that double shoulder, we can then mate the Carbon Inner Tube with our AIH perfectly using our two-part epoxy, AGUSSE. And that's the final step of our preparation process.

### Building the Complete System

At the end of the standard preparation process we should have two\* raw components: the chamfered main shaft as well as the CTI & AeroInsert-H. These next steps are where our production process truly shines. After joining the CTI and AeroInsert-H pairing to the main shaft via vacuum pumping, we take multiple measures of quality control. All in all, we believe in providing our customers with the best, money and time aside. Therefore, we sort our arrows after building them. For although we do vacuum pump our completed insert(s) into the main shaft to assist in efficient gluing, we know that there is still variance. To overcome this, we weigh, hand label, and sort every shaft to a grain.

### Completing the AeroBolt

Now with a weight-labeled, ACS equipped shaft, we begin the last steps of building an AeroBolt. Though before we claimed that its capacity to harmonically dampen was its most significant feature, there is arguably another significant feature about all our AeroBolts—they all are first dynamic bend indexed with our PAPS before fletching. (See the previous spread to learn why this is which an important step.) After this, of course, we do fletch Aerovanes according to that index with our Aerovane Jig. Finally, we square the nock end of the completed AeroBolt one last time.

### Additional Notes

All AeroBolt\*\* are optimized for the Firenock lighted nock system, fletched with Aerovane II or Aerovane 3 vanes, and equipped with an AeroConcept System compatible AeroInsert-H. Our standard vane configuration is three vanes, respectively, in white, yellow, and red. Custom vane configurations (zero, two, or four) as well as custom color combinations are also available but with extra charge. All Aerovanes on AeroBolt are fletched with the Firenock Aerovane Jig and glued on AG0600. AeroInserts are available in aluminum (~17 grain) or stainless steel (~50 grain). Lastly, note that you can order and re-order your AeroBolts in specific weights and lengths.

\*As of 2018, like seen in the diagram for AB2-200, there is an option to add another Carbon Inner Tube at the back of the arrow. This addition is the AeroConcept System 2.0 and increases the total of raw components to three instead of two. For clarification, Dragon Slayer always has three raw components but cannot be equipped with the ACS.

\*\*While all AeroBolt II also come with an AeroPoint option, AeroBolt III do not due to cost in order to maintain the same list price.



The AeroBolt II-200 (AB2-200) crossbow arrow is engineered and designed for general purpose.

AB2-200 achieves maximum speed and flight stability with AeroPoints as well as any aerodynamic designed broadheads like the Dagger. AB2-200 is offered in lengths from 20-26 inches and is built with a 0.001" straightness shaft. The amazingly straight flight of AB2-200 is due to its variable spine design as an effect of the AeroConcept System; AB2-200 has a spine in the front of 0.060" and a spine at the back of 0.200." The weight of AB2-200 with an AeroInsert and the AeroConcept System is about 285 grains excluding vanes, a nock, and a point. As a quality mark for all AeroBolt, they are first dynamic bend indexed as well as hand-marked with complete shaft weight, overall length, and CTI length.



The AeroBolt II-Dragon Slayer (AB2-D2) crossbow arrow is the big brother of the AeroBolt II-200.

AB2-DS is engineered for maximum momentum and penetration power. Built for African big game, it is super heavy in weight as many African range game laws state that you must use an archery projectile of no less than 1000 grains when hunting the African Big Five. AB2-DS is offered from 16-26 inches and, unlike any other crossbow arrows, has a 0.092" thickness of carbon throughout its entire length. Unlike AB2-200 which utilizes the AeroConcept System, AB2-DS has two inner shafts that sit nearly throughout the entire length of the main shaft. These two inner shafts are engineered to be super heavy and super stout. Additionally, AB2-DS comes standard with a stainless AeroInsert-H and ready for the Firenock lighted nock system (C, D, F, J, M, Q, or U) with a pre-installed Extreme Shock End Cap. A 26-inch AB2-DS's expected total weight (excluding vanes, a nock and a point) is about 726 grains. Also, from our field staff reports, AB2-DS has been found to be the best crossbow for the 700lbs+ wild boars hunted in southern US states such as Georgia and Texas. As a quality mark for all AeroBolt, they are first dynamic bend indexed as well as hand-marked with complete shaft weight, overall length, and CTI length.



The AeroBolt II-G (AB2-G) is the best of both worlds crossbow arrow.

AB2-G is a companion product for the Firenock Traumahawk broadhead for true instant knockdown via blunt force trauma. AB2-G is offered in lengths from 20-26 inches and is built with a 0.001" straightness shaft. Lighter than AB2-DS whilst heavier than AB2-200, AB2-G is specially designed for maximum frontal end mass to best transfer the amount of kinetic energy needed to penetrate deep into big game animals. A 22 inch AB2-G (excluding vanes, a nock and the Traumahawk) weighs in at about 352 grain. As a quality mark for all AeroBolt, they are first dynamic bend indexed as well as hand-marked with complete shaft weight, overall length, and CTI length.



The AeroBolt III (AB3) takes everything you love about AeroBolt to another level.

In 2019, with the introduction of the AeroWeave300, we decided to combine the benefits of our highest performance shaft with the technology behind the AeroBolt II. Due to the fact that AeroWeave is significantly more expensive, AeroPoint is not a part of the standard AB3 package to maintain average lineup pricing. As a quality mark for all AeroBolt, they are first dynamic bend indexed as well as hand-marked with complete shaft weight, overall length, and CTI length. AeroBolt III is available for the 200 system (AB3-200), the Dragon Slayer system (AB3-DS) and the Gyro system (AB3-G).

Firenock, for over fifteen years now, has been an arrow component company. A long time awaited, AeroWeave is Firenock's unique take on the arrow itself. Tackled like all Firenock products, every aspect of the design has been optimized—spine, weight, and strength. The carbon fibers used for AeroWeave shafts are of a different class. To maintain the same standard specifications but provide the most optimized arrow, Firenock uses ultra thin, ultra strong 4K fibers. And with thinner fibers, there is more lay for more manipulation.

## The Weave Construction

While a large section of our construction takes from the original in that it has a linear lay for spine strength, its most unique feature is in its complex lays, its weaves (US Patent: # 10,145,643). Due to the harsh environment of archery, strength at every axis is crucial. If you look closely at the wrap lay to the right, three of the four sections involve small squares. These squares are actually that "weave." And those "diamonds" are also that weave, but rotated 45 degrees. But why does a weave matter? Well, with a weave, multiple axes can be covered at once. Further, if you turn that weave and lay it on top of itself, as will happen during the rolling of the carbon fibers, even more, infinitely more, axes will be protected.

But, of course, as we do for many Firenock products, we went a bit further. Note the top image below. This is an example of what most other weaves on the market look like. Do you see the difference between it and our weave? Standard weave has a ratio of 2:1 (or sometimes even 3:1) and our weave has a ratio of 1:1. This allows for absolutely no gaps and balanced strength from all sides and axes. Again, a step further, but we at Firenock believe it's worth it.

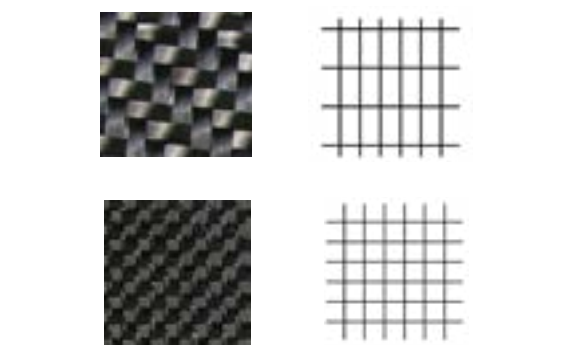
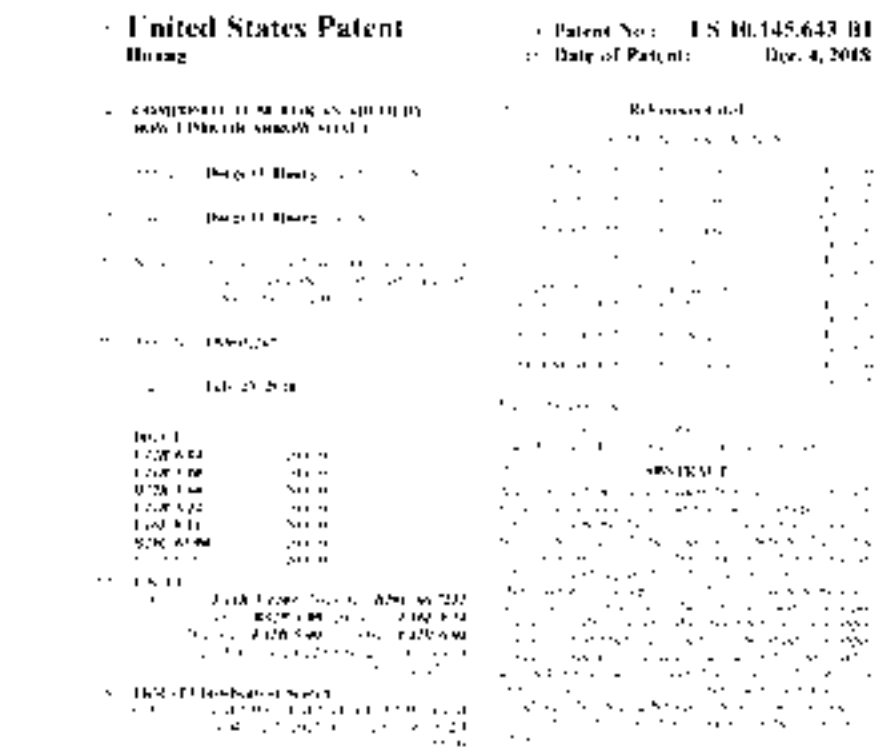
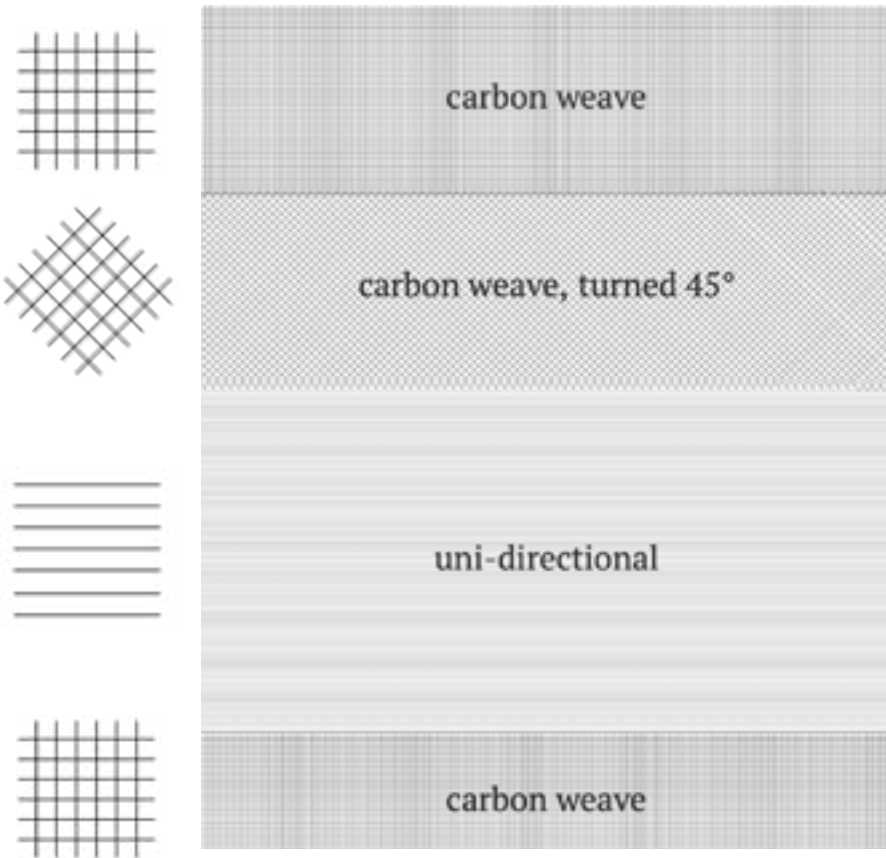

Almost, immediately after the launch of the AeroWeave, there was a lot of demand to cover the very popular slim and ultra-slim sizes. But at such a small size, it was exponentially more difficult to create the perfect arrow without compromising our carbon weave. For 2022, we're finally satisfied with our solution: micro carbon weave.

**AeroWeave's unique construction is only possible due to its unique 4K carbon fibers. For the AeroWeave Micro Series, the same fibers are still utilized, but manipulated in a whole new way.**

What is carbon fiber anyway? Carbon fiber is composed of carbon atoms artificially bonded together to form a long chain. As a result, the fibers are extremely stiff, strong, and light. But exactly how stiff, etc., the carbon fiber is depends on how refined the original carbon fiber chain was.

Here's another way to look at it. When making noodles, you start with a ball of dough. The quality of the flour you use in the dough will effect the character of the pasta. How chewy will it be? How malleable? Can the dough be manipulated to be as thin as spaghetti? As angel hair? While some of that depends on methodology, a lot relies on the dough itself.

"Firenock uses ultra thin, ultra strong 4K weave fibers." When we say that, we are referring to the high quality of carbon we use. Carbon weave, by nature, requires more. More carbon and more resin, the stabilizing matrix used to form the composite. But more material meant that when we rolled it back up, it would not meet the standard requirements. It would be too heavy or have too large of an outer diameter. Therefore, we chose a carbon fiber that was refined enough that when pulled thin, there was no sacrifice in strength. So while the original weave was the same, it was made with a thinner fiber to begin with and resulted in a longer overall lay.

For slim (0.204" ID) and ultra slim (0.166" ID) size shafts, however, we learned we could not use the same approach. While the patented construction stayed the same (like on a unidirectional construction), the prototypes came back too thick, too heavy, or too irregular. The construction had to fit more while taking up less space. So we pressed the same highly refined 4K carbon fiber even thinner than before and laid it more dense than before (see samples below).

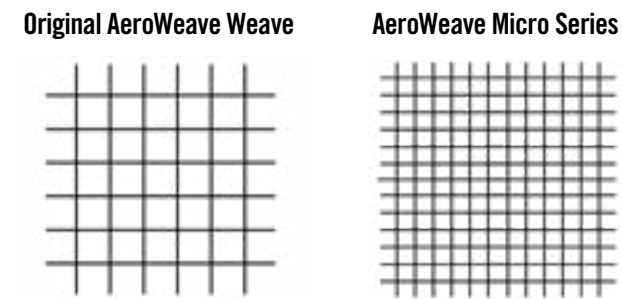

As a result, a micro carbon weave was born. With the same straightness, loop strength, torque strength, and torsion strength as the original AeroWeave but in a package less than half the size, Firenock AeroWeave204L and AeroWeave166 are available in three spine ratings each: 300, 350, and 400. Note that the original AeroWeave204 is made with the same 4K density as the rest of the AeroWeave instead of the micro (1K and 1.5K). AeroWeave315 is in the process of getting a micro rehaul in 1.5K while the long-awaited AeroWeave380 will launch in 1K.





# AEROWEAVE™ The Lineup

Since 2019, Firenock has added new AeroWeave sizes to our lineup every year. For 2019, we began with the standard vertical size, 0.246". After AeroWeave246's success, for 2020, we added 0.300" and 0.315". Last year, we developed the new micro carbon weave and process for the 0.166" as well as the 0.204" Light (0.204L) sizes.

The AeroWeave Series involves six sub-series. From ultra slim sizes with the new micro carbon weave to large sizes like 0.380" ID, AeroWeave offers arrow shafts to cover all needs. Note that all sub-series are available in up to four spine ratings and up to three lengths but make sure to double check the webstore for current stock.

Product Code	Spine	ID	OD (in/mm)	Fiber	Layers	Color	Weight +/- Dz	Length	AVE. GPI	MSRP*/Dz
AeroWeave166-300	300	0.166"	0.249	6.32	1K	4	Black	1 grain	32"	10.5 \$219.95
AeroWeave166-350	350	0.166"	0.248	6.30	1K	4	Black	1 grain	32"	8.6 \$219.95
AeroWeave166-400	400	0.166"	0.232	5.90	1K	4	Black	1 grain	32"	8.2 \$219.95
AeroWeave204-30L	300	0.204"	0.270	6.85	1.5K	4	Black	1 grain	32"	9.8 \$219.95
AeroWeave204-35L	350	0.204"	0.265	6.72	1.5K	4	Black	1 grain	32"	8.8 \$219.95
AeroWeave204-40L	400	0.204"	0.261	6.63	1.5K	4	Black	1 grain	32"	8.0 \$219.95
AeroWeave204-300	300	0.204"	0.283	7.20	4K	4	Black	1 grain	32"	12.2 \$159.95
AeroWeave204-350	350	0.204"	0.280	7.12	4K	4	Black	1 grain	32"	11.1 \$159.95
AeroWeave204-400	400	0.204"	0.272	6.90	4K	4	Black	1 grain	32"	10.1 \$159.95
AeroWeave246-300	300	0.246"	0.304	7.72	4K	4	Black	1 grain	32"	9.8 \$159.95
AeroWeave246-350	350	0.246"	0.299	7.59	4K	4	Black	1 grain	32"	8.7 \$159.95
AeroWeave246-400	400	0.246"	0.292	7.42	4K	4	Black	1 grain	32"	7.3 \$159.95
AeroWeave300-200	200	0.300"	0.353	8.97	4K	4	Black	1 grain	22", 26"	10.3 \$159.95
AeroWeave300-300	300	0.300"	0.344	8.74	4K	4	Black	1 grain	32"	10.0 \$159.95
AeroWeave300-350	350	0.300"	0.342	8.69	4K	4	Black	1 grain	32"	9.3 \$159.95
AeroWeave300-400	400	0.300"	0.340	8.64	4K	4	Black	1 grain	32"	8.7 \$159.95
AeroWeave315-300	300	0.315"	0.359	9.13	4K	4	Black	1 grain	32"	10.0 \$159.95
AeroWeave315-350	350	0.315"	0.358	9.09	4K	4	Black	1 grain	32"	9.3 \$159.95
AeroWeave315-400	400	0.315"	0.357	9.07	4K	4	Black	1 grain	32"	8.7 \$159.95



# The Weave Outer Shell SPORTWEAVE™

The AeroWeave has been out now for nearly three years and has become an integral part of many a shooter's kit. For those, however, who find AeroWeave's price tag a bit too hefty, we developed the SportWeave Series. Designed still with optimal spine, weight and strength, SportWeave boasts a 55% decrease in price from AeroWeave.

How can you keep the benefits of AeroWeave at less than half the price? Simply put, the Weave Outer Shell.

Before going forward, we highly suggest that you look to the prior AeroWeave pages to learn about our anomalous weave design.

Now, after understanding the essential characteristics and advantages of our weave, it's important to note how and how much of this weave we use for the AeroWeave versus the SportWeave. To start, for the AeroWeave, there are actually three separate and unique layers of the 4K weave. However, like the image to the right suggests, for the SportWeave, our 4K weave only makes up one layer, hence the "weave outer shell." This means that SportWeave still has some of the awesome benefits of AeroWeave, such as torsion strength and ultra-durability, just not to the same spectacular degree.

As for other details, here's a quick rundown. Due to our precision proprietary process, we believe it is now inconsequential to hone in on straightness. Why? Well, for those who are interested, the "worst" arrow we offer now has about a 0.0015" straightness. But further, we have also proven that any arrow that is within 0.008" straightness can and will shoot identically like others of better straightness as long as it is built with the right tools, approach, and with the correct components. And what about consistency? Well, in addition to the fact that each batch of Firenock shafts are factory sorted and marked within a grain of one another, we will try our best to ensure that each of the completed arrows in your batch will have the same weight all around.

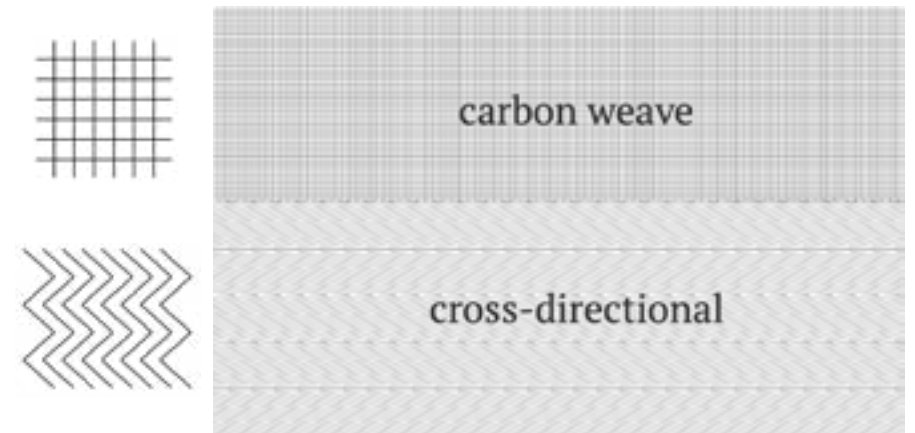

Carbon arrow assembly. What exactly makes a finished or complete carbon arrow different from another?

Variables such as type(s) of insert(s), type of shaft, workmanship, vane placement, etc. are often the things people first think about. And, this time, with the SportWeave, we agree! All those variables and more are indeed what we believe make a finished carbon arrow exceptional. For this reason, SportWeave carbon arrows will only be sold via our Certified and Trained Firenock Dealers/Pro-Shops. At Firenock, we have no doubt that in the hands of a real pro, SportWeave, though only the second best shaft on the market (just behind AeroWeave, of course), can give you the best "bang for your buck." Both literally and figuratively.



Product Code	Spine	ID	OD (in/mm)	Fiber	Layers	Color	Weight +/- Dz	Length	AVE. GPI	MSRP*/Dz
SportWeave246-300	300	0.246"	0.304	7.72	4/2.8K	3	Black	1 grain	32"	9.8 \$89.95
SportWeave246-350	350	0.246"	0.299	7.59	4/2.8K	3	Black	1 grain	32"	9.0 \$89.95
SportWeave246-400	400	0.246"	0.292	7.42	4/2.8K	3	Black	1 grain	32"	8.9 \$89.95
SportWeave300-200	200	0.300"	0.351	8.92	4/2.8K	3	Black	1 grain	22"	10.2 \$89.95
SportWeave300-20H	200	0.300"	0.351	8.92	4/2.8K	3	Black	1 grain	22"	11.8 \$89.95

# BROADHEADS Spacers

While Firenock has had field points on the market for years now, we've only recently entered the broadhead market. Fixed broadheads include Traumahawk, Dagger, and the new Stalker Dagger while mechanical broadheads include the SwingBlade and Stalker SwingBlade. This tri-part spacer series help unleash their full potential.



## Aluminum Slant Spacers

These spacers are a companion product to most broadheads and field points. 0.5mm thick, these spacers are "slanted" in shape with one side boasting a diameter of 8mm and the other 9mm (see closeup images to the left). With this unique design, one can easily relieve the diameter difference between common vertical bow arrows (8mm) and crossbow arrows (9mm). For long-term durability and good looks, these 0.82+/-0.03 grain spacers are made of 7075-T5 Aluminum and are Type II hard anodized. Available in packs of six.

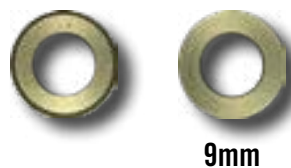

## Titanium Spacers for Broadhead Alignment

As their label suggests, these spacers are designed to perfectly align your broadhead according to your own personal configurations. See, often times, when you fully screw in your broadhead into an insert, the broadhead will not sit where you'd like it to. Available in packs of 12 and in six sizes—0.10mm, 0.20mm, 0.25mm, 0.30mm, 0.40mm, and 0.50mm—these GR2 Titanium spacers all weigh less than a grain and will give just enough leeway to turn a broadhead that much less/more.



## Copper Crush Spacers

Many field points and broadheads on the market are not exactly the same weight as claimed. Some 100 grain broadheads are actually 96 grain, and we've found some up to 8 grains heavier than advertised. We also noticed that some inserts are not deep enough to accommodate a point, causing a small gap to appear. To address these issues, we now offer Copper Crush Spacers. Available in four sizes—[1] 1.0mm or 4.0-4.5gn, [2] 1.3mm or 5.0-5.5gn, [3] 1.5mm or 6.7-7.2gn, and [4] 1.8mm or 7.7-8.2gn.

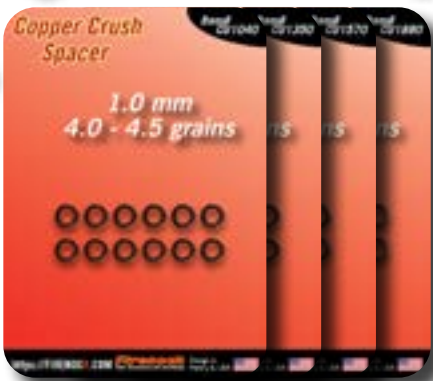

# Blunt Force Trauma TRAUMAHAWK™

Utilizing blunt force trauma, the Traumahawk is our invulnerable broadhead designed especially for high speed crossbows. To understand exactly how special it truly is, first, strip back every assumption you have about what a broadhead should look like and act like...

A broadhead, according to the Merriam-Webster dictionary, is "a flat, pointed arrowhead having sharp edges and made of steel." Two significant characteristics are mentioned in this definition—pointed and sharp. Interestingly, neither apply to Firenock's Traumahawk.

Often, when the quality of a broadhead is discussed, its ability to pass through an animal is directly correlated to one's opinion of it. If we apply such a system of thought to the Traumahawk, most people's opinion would be really low. Why? Because our crossbow broadhead is not meant to "pass through" an animal.

## Blunt Force Trauma

When most hear the phrase "blunt force trauma," the first thing that comes to mind is usually some sort of injury. Such an understanding is definitely relevant here. Blunt force trauma is also known as the "initial trauma." Unlike most broadheads that boast how pointed or sharp they are, as you can see in the image to the right, Traumahawk is not pointed—its literal "point" is in fact an edge. Designed to working a bit like the Native American's lethal weapon, the tomahawk, Traumahawk transfers the maximum amount of kinetic energy during the initial or first contact of your arrow to the game. Traumahawk does not pass through but tears through.

## Specifications

Made of solid stainless steel and weighing 175 grains (11.34 grams), the original Traumahawk is machined through a high-pressure precision, die-cast (HPDC) process. This casting method results in a much stronger and tougher steel. To ensure concentricity when you are installing Traumahawk on your crossbow bolt, it is also equipped with patented FACT, our Double O-ring System.

For summer 2024, the Traumahawk manufacturing process transitions from HPDC to Metal Injection Molding (MIM). The MIM Traumahawk sacrifices impact strength for precise weight distribution and cleaner shape intricacy for an overall more quiet and aerodynamic flight. Both Traumahawk versions will be available until the HPDC Traumahawk runs out.

*Note : To take advantage of both fixed, two blade Firenock broadheads, Dagger and Traumahawk, two things are crucial. [1] Make sure the broadhead is at the vertical position when shot (12 o'clock) and [2] the first dynamic bend of the archery projectile matches that vertical position. To learn more about broadhead positioning as well as the first dynamic bend, see the adjustment spacers and the Professional Arrow Preparation System (PAPS) spread.*



# DAGGER

The Dagger, now available in two materials, in up to two approaches, and in up to seven weights, is our compound, single bevel grind equipped broadhead. To comprehend such a design, its important to start at a bevel.

Simply put, a bevel is a constant slope. In the instance of a weapon or, more specifically, a broadhead, such bevels are used to create a point or sharp edge. These usually involve double beveled edges, defined by a slope on both sides. Here is where the Dagger differentiates from all others—it does not have a slope on both its “sides,” it has a total of six complex beveled edges from all sides. See, a simple bevel involves, as aforementioned, a constant slope. Complex bevels, on the other hand, have multiple slopes. To clarify, the Dagger has two complex bevels on all of its edges and then two at its base. Each with its own individual slanted slope, these six bevels work together, are “compounded,” to provide rotation not only during initial contact with the game but all the way through the animal.

## Dagger Titanium

Dagger Titanium or Ti is made from high pressure, die-cast GR5 Titanium and then machined processed. The Dagger Ti pulls its design near exactly from the original Dagger (DAGGER, 125 grains) to improve silent flight while still maintaining its weight at 85 grains. This light weight makes it an ideal broadhead for those who are using AeroConcept 1.0 or 2.0 due to the carbon inner tube’s (s’) already additional weight. Note that these come in single packs unlike all other Daggers, which come in packs of three.

## Stalker Dagger

After the release of the Stalker Series in 2020 and the Stalker Swingblade in 2021, the Stalker Dagger was the logical next step. This 100 grain, screw-on fixed broadhead pairs with both the Stalker AeroStem AeroInserts. Pair it with Stalker AeroInsert-H to take advantage of the AeroConcept System. Learn more about this fantastic series on the Stalker spread.

## Metal Injection Molding (MIM)

Dagger was originally available in only two weights, 100 grains, for those who prefer a flat weight, and 125 grain for those who prefer a little heavier of a broadhead. Both were paced through a high-pressure die-cast (HPDC) process then machine processed. Note that, although extremely durable, HPDC processed stainless steel has an extremely low accuracy yield i.e. if 100 pieces were made, only 20% is +/-1 grain of the intended weight. Therefore, note that when purchasing DAGGER or DAGGEC today, there is some weight variance e.g. Dagger 125 could be 123-127 grains.

When the possibility of using another process become possible in 2020, we jumped on it. Metal Injection Molding, or MIM, offered the opportunity to make broadheads with the complex geometry Dagger’s design requires without having to toss 80% of the lot. All Daggers will eventually be made via MIM and HPDC blades will be faded out.

Currently, eight stainless steel Daggers are available for purchase. The original two HPDC Dagger 100 and Dagger 125, as well as the six new MIM Daggers from 100-250 grains. All Daggers are equipped with FACT, which includes the Double O-ring System on the neck for self-concentricity.



# SWINGBLADE™ The Future's Mechanical Broadhead

# The Blades SWINGBLADE

SwingBlade is a mechanical broadhead that utilizes a deployment system never before seen. As its name implies, the three blades on a SwingBlade deploy by swinging out from their clasped position upon impact (US Patent # 9803963). This design allows it to be used on high speed archery projectiles up to 550 fps with accuracy due to a minimum crosswind signature during flight (~3/4"). Further, designed as a completely interchangeable series, the head, blades, and bodies can be field swapped.

## [A] The Head



The SwingBlade standard head is made of stainless steel. It has a sharp pyramid design. The three channels of the head are designed to allow the screws that unite that head with the body to be flush to the base of the head for structural integrity. These channels additionally lower the surface contact, acting instead as air ram chambers and blood flow channels during its cutting phase.

## [B] The Blades

All four blades utilize the single bevel front and back design. They are also made of 0.5mm thick surgical grade stainless steel hardened to no less than 52 HRC. See the right side of this spread for a more in-depth look at what blades we currently have to offer.

## Deployment Method

To clarify, a SwingBlade's blades will only deploy when there has been a change in density; the only thing actually keeping the blades from swinging open is a rubber O-ring. Therefore, only after contact with something of a different density than air such as flesh will the single bevel grind blades open via the hinge that is directly perpendicular to the impact surface. The hinge pin screws, although extremely tiny in diameter (0.175mm), are critical in this application, which is why we choose to make them from HRC60 CRMO steel. These pins also allows one to easily replace or switch out blades

For illustrative purposes, see the references below. [1] shows most SwingBlades before deployment (~3/4"), [2] shows a SwingBlade equipped with either the Falcon or Raptor blades deployed (1 3/16"), [3] shows SwingBlade equipped with the Talon blades deployed (1 2/3"), [4] shows SwingBlade equipped with the Saber blades deployed (1 13/16"). Ratios correct, images enlarged for demonstrative purposes.

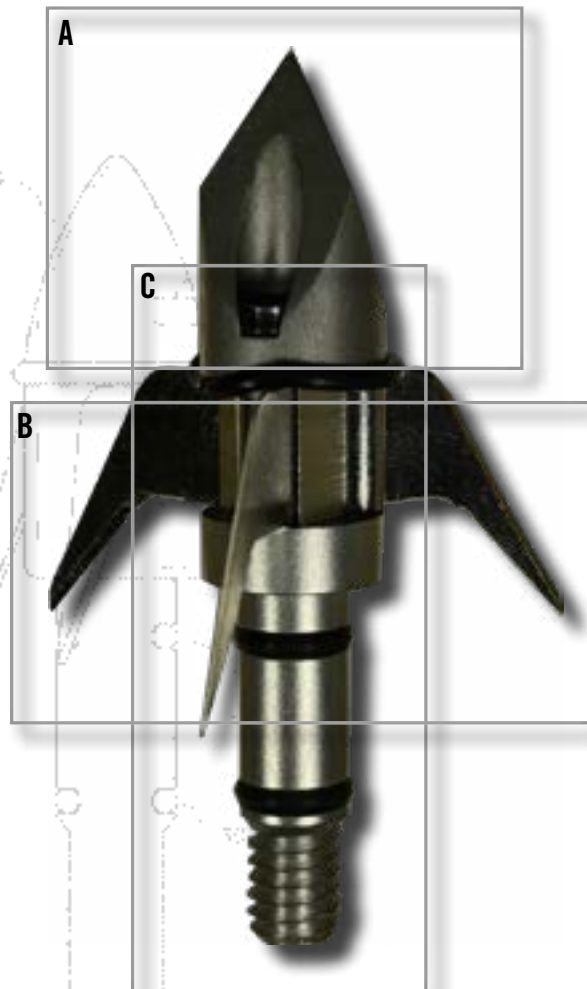

## [C] The Bodies

All three bodies, like all Firenock broadheads and field points, are equipped with FACT 2.0, our Double O-ring system that helps with self-concentricity. The aluminum body (far left image to the right) weighs 22 grain while the two stainless bodies weigh 47 grains (center to the right) and 72 grains (right to the right) respectively.

Note : The unusual weights of all three bodies is intentional. When any body is matched with the standard head and any SwingBlade blades, the full broadhead will end up being either 100 or 125 grains, +/- 1 grain.



With the introduction of the SwingBlade broadhead, two unique blades were announced: the Falcon and the Raptor blades. Since then, after hearing what our customers have to say about the original lineup, we added the Talon as well as the Saber. Read about their designs below.



## Falcon Blade (2018-)

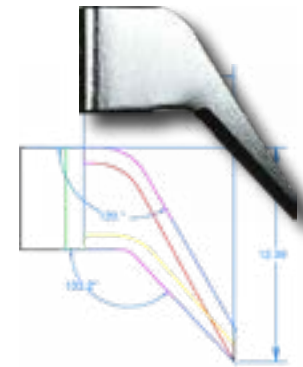

The most aerodynamically efficient of all SwingBlade designs, the Falcon blade has the lowest crosswind signature and is the quietest of all Firenock broadheads. Through designed with a high cutting angle, there is a minimal amount of drag when a set of these blades passes through the wind. Falcon blades remain as a great choice for archery projectiles up to 550fps, even in 35mph crosswinds.

## Raptor Blade (2018-)

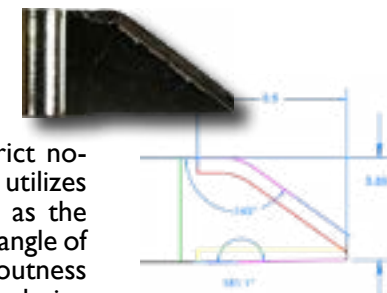

Designed to address very strict no-barbing laws, the Raptor blade utilizes the same single bevel design as the Falcon but with a background angle of exactly 89 degrees. Their stoutness makes these blades a great choice when durability is of great import.

## Saber Blade (2020-)

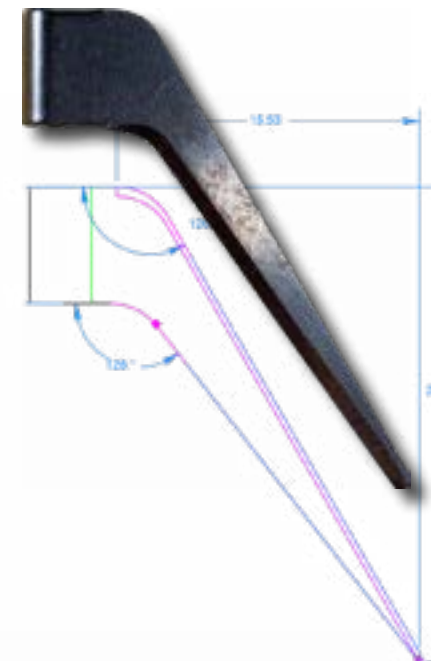

After the introduction of the Talon blade, many vertical bow archers who prefer arrow speeds lower than 305fps still wanted an alternative option with the maximum cutting diameter, aerodynamic efficiency aside. Saber's 15mm wide active blade with the same ultra-efficient forward angles as Falcon, of 120 degrees, is our response. Just like every other style, this blade is also made of 420 Stainless Steel and hardened to at least 53 HRC.

## Talon Blade (2019-)

The Talon blade was designed to further address the original SwingBlade blades' lack of blood trail. Specifically, we wanted to ensure that we could give our customers what they desired without giving up too much accuracy for bow speeds lower than 315fps. We believe with a 70% longer cutting radius than the 2018 versions, we succeeded. Also note that with a back swing angle of 161 degrees, a more dramatic impact occurs on a slower and heavier arrow, which most archers who uses today's high let-off bows with high FOC arrows would prefer.

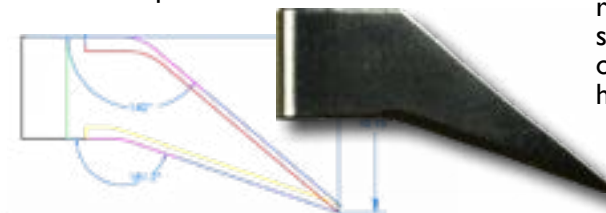

With one head, three bodies, and four blades available, there are twelve unique packs available for purchase.

Each of our SwingBlade packs are assigned a unique six character code. "SWBL," the first four characters, simply refer to the first two letters of the compound word SWingBlade. The next letter, either "F," "R," "T," or "S", represent which set of blades are in the package. And finally, the last letter, either "A," "S," or "H," represent which material the bodies are made from—aluminum ("A"), stainless steel ("S"), or stainless steel ("H" for heavy).



## The SwingBlade Practice Weight Ring Set

Due to its small crosswind signature, SwingBlade has proven to fly like a matched weight AeroPoint. For those who would still prefer to practice with the actual body and head of the SwingBlade instead of a parallel field point, the Practice Weight Ring Set was created. A package includes three 303 Stainless Steel rings that, as implied, match the weight of the any set of our blades, +/- a grain. It also includes six fastening screws as well as three extra O-rings.



# STALKER™ Flipping the Insert Inside Out

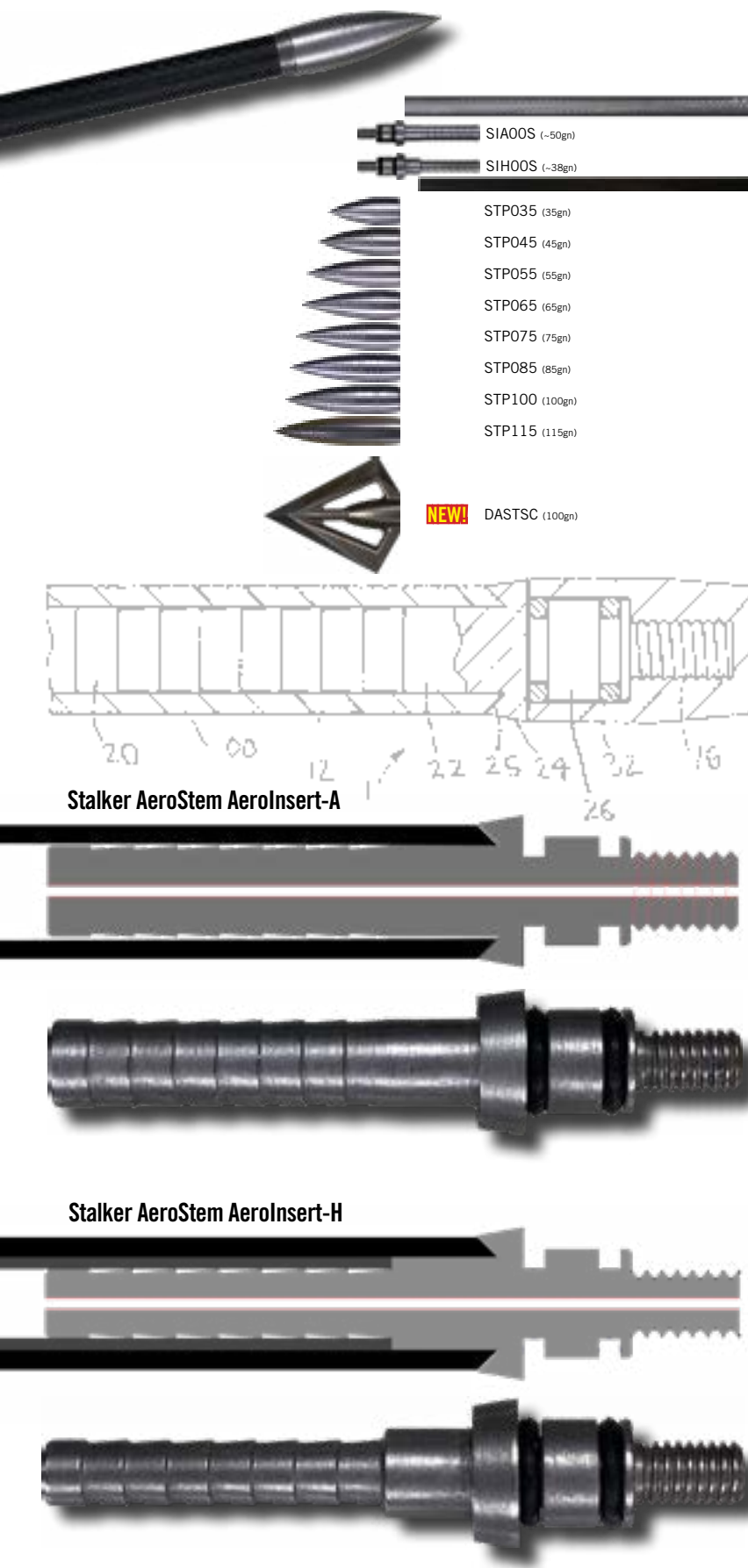

Taking advantage of every insert technology we've created so far including those available for AeroInsert-A, AeroInsert-H and AeroPoint, the Stalker Series reapplies them for the 0.166" ID size shaft. Flipping the traditional insert literally inside out, our AeroStem System (US Patent: 10.859.354) allows for field changes from field point to broadhead. This series meets the challenge of the harsh environment of global competitions head on. For 2022, the beloved Dagger fixed broadhead has been adapted for use with the Stalker system in 100 grain.

### The AeroStem™ System

Target archers who use 0.166" class shafts and prefer not to use outserts have few alternatives past glue-in points. This is unfortunate because when a field point eventually becomes bent or damaged, the arrow becomes unusable. While others try to avoid that damage through the use of more durable tungsten points, their price at \$200 to upwards of \$400 per dozen makes this an impractical alternative. At Firenock we have taken an entirely different approach, one we call the "stem system" aka AeroStem Series. Together, the Stalker AeroInserts (SIA/H) and interchangeable Stalker AeroPoints (STP) as well as Stalker AeroStem SwingBlade (SBST) broadheads mate seamlessly with a 0.166" class shaft.

### The Stalker AeroInserts

The Stalker Series includes two insert versions: the Stalker AeroInsert-A (SIA) and The Stalker AeroInsert-H (SIH). Overall, they utilize up to three patents. Every insert is equipped with our reverse tapered shoulder for durability as well as our patent-pending dual O-ring for perfect concentricity. The addition of our patented double shoulder on our SIHs allow for use with AeroConcept carbon inner tubes. Installation with a CT1160 will result in a shaft with greatly reduced oscillation (i.e. less energy waste) as well as a stronger frontal end.

For those who love the simplicity of our AeroSystem components, our SIAs are great upgrades. Including the aforementioned technologies, the Stalker inserts, even at their small size, are hollow for a light weight and easy Firenock lighted nock system installation i.e. no push-back pressure during ESEC gluing. Their hollow shape is only made possible due to a new EDM drilling process, making a 0.5mm hole through the entire insert. Finally, for those for a quick transition into hunting season, our two-part system allows for replacement with most broadheads.

# SwingBlade Points STALKER

Before 2021, all Firenock field points and broadheads could only be equipped on 0.166" ID shafts via our AeroOutserts. However, with the 2020 release of the Stalker System including the Stalker AeroInsert-A and AeroInsert-H came the opportunity for the Stalker SwingBlade.

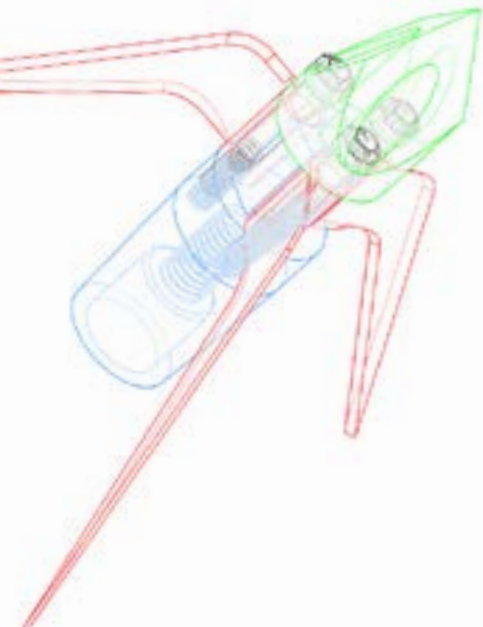

Equipped with the interchangeability that both its parent series boast, the Stalker SwingBlade includes two all new AeroStem bodies that mate perfectly with the current Stalker AeroInserts as well as the SwingBlade head and blades for use on ultra slim size shafts. Easily replace these bodies with the original Stalker AeroPoints for practice.

### Specifications

Examples of popular arrows with a 0.166" ID include the Firenock AeroWeave I 66, the Black Eagle Deep Impact or X-Impact, the Carbon Express Maxima SD, the Element Storm, and the Easton Injexion. Firenock Stalker AeroInserts and Stalker AeroPoints are made with 420 Stainless Steel and all have an outer diameter of about 7mm. In terms of weight, our Stalker AeroInserts are 38 grains (SIH) and 50 grains (SIA) respectively while the AeroPoints come in eight weight sizes: 35, 45, 55, 65, 75, 85, 100, and 115 grains. While the Stalker SwingBlade bodies have the same OD at 7mm, the 75 grain body is made of 7075 hard-anodized Aluminum while the 115 grain body is machined from 303 Stainless Steel.

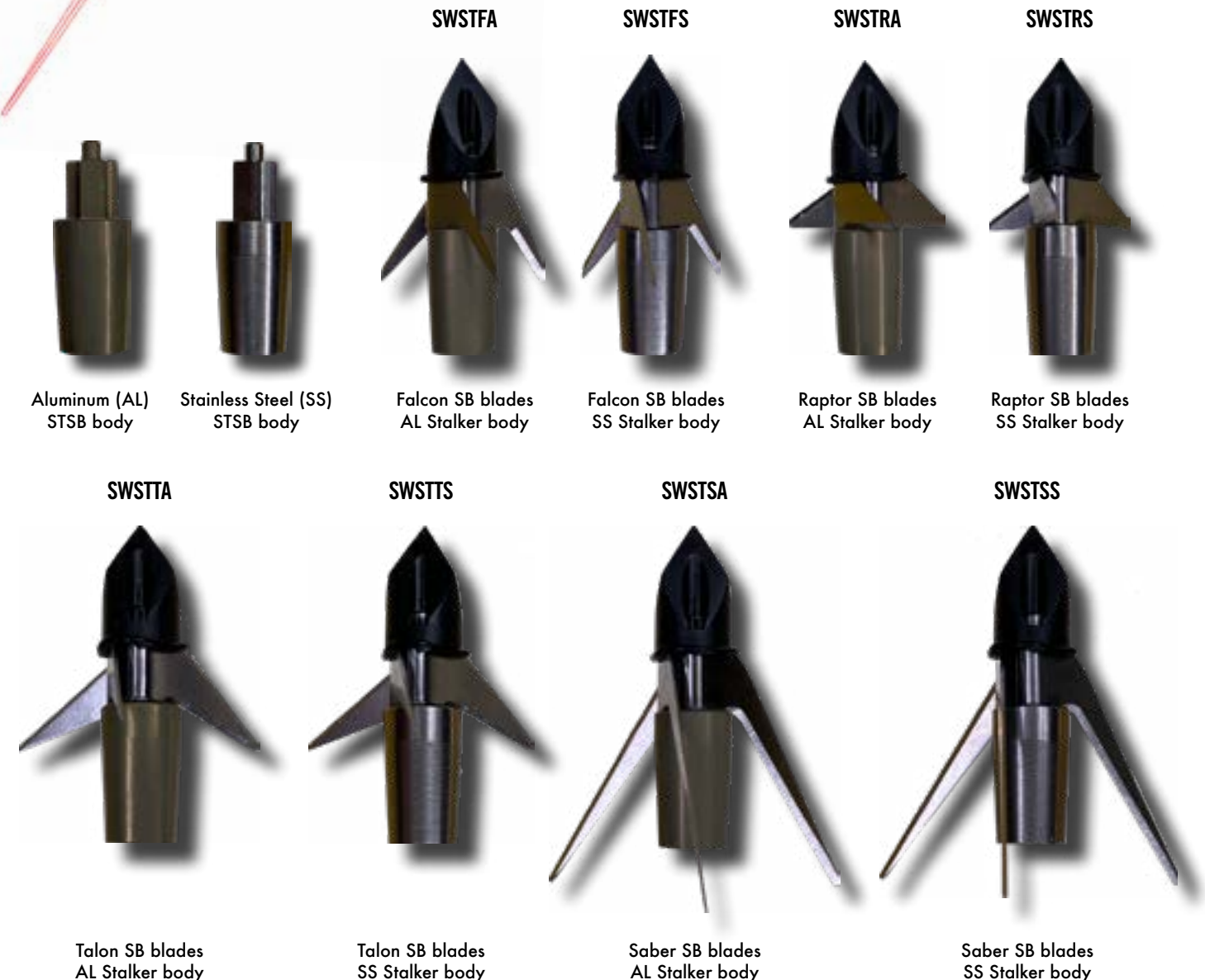

# AEROINSERT SUMMARY

Currently, there are dozens of styles of Firenock in/outserts available to pair an arrow with a field point or broadhead. While we've detailed the technologies and uses for each series in the past twenty or so pages, we hope this summary serves as a tool to help clarify everything you need to know before selecting which in/outsert is right for you.

## 1. What is the internal diameter (ID) of your arrow?

Based on arrow sizes, there are four major component types in the Firenock in/outsert offering.

1. If the internal diameter (ID) of an arrow shaft is smaller than 0.200," there are two ways to support the standard 8-32 thread. For the longest time, Firenock's only solution was the outsert. An outsert has a cap-over shaft design. Because 8-32 threads themselves have an outside diameter (OD) of 0.164," they can be inserts into a 0.166" ID arrow. Note that while it makes one of the strongest connections with a screw-in field point, its installation requires a lot more care as there is no simple way to guarantee concentricity besides frequent spinning.
2. The new, other option for shafts with an ID smaller than 0.200" is the unique Firenock Stalker Series's stem insert.
3. If the ID of an arrow shaft is smaller than 0.230" but bigger than 0.200," the ideal component is the half-out insert. As the name suggests, a half-out is an insert where half remains outside the shaft while the rest is inside. This design is a compromise between an outsert and insert because it remains relatively durable and boasts better concentricity.
4. If the ID of an arrow shaft is smaller than 0.365" but bigger than 0.230," then a "normal" insert is the best option.

## 2. What material would you like your in/outsert to be made of?

For our in/outserts, Firenock offers up to four main materials.

1. Aluminum, relatively lightweight and priced, is our most popular material. Currently, we offer two different grades, 7075-T5 Aluminum (2.81g/cm<sup>3</sup>) and 6061-T6 Aluminum (2.7g/cm<sup>3</sup>). Note that, being close to 30% more affordable than 7075-T5, or the "A" style, and the most economical of any of our inserts, 6061-T6 or "C" style inserts are only available from Firenock Certified and Trained Dealers. The AeroOutserts are unique in that they are made from an especially annealed 7075-T6 Aluminum.
2. For those who want a higher FOC, long term durability, and don't mind the price, stainless steel is our most recommended material. Note that all inserts marked with either an "G," "H," "M," or, of course, "S," are made of stainless steel. The only difference between the codes is quantity of material i.e. "S" being lightest and "G/M" being heaviest.
3. Three years ago, we added brass (8.73 g/cm<sup>3</sup>) to our lineup for customers who want a higher FOC but do not like the cost involved with stainless steel. These also are only available from Certified and Trained Dealers.
4. Finally, for those who want extreme durability but want a medium weight setup, titanium, specifically GR5 (4.43g/cm<sup>3</sup>), is our premium material. 50% lighter than aluminum but 250% stronger than 303 Stainless Steel, this material has no faults but its price.

## 3. What patented technologies do you want to take advantage of?

As of 2022, up to two plus two patented technologies are implemented on our in/outserts.

1. Blood Channel Technology (US Patent # 8668605) appears on every Firenock AeroOutsert and provides relief to the outsert itself during target extraction.
2. AeroStem Technology (US Patent # 10859354) is featured in the new Stalker AeroInserts, notably allowing for point and broadhead changes on ultra slim arrows.
3. All Firenock inserts are equipped with Reverse Tapered Shoulder Technology (RTST, US Patent #8403777), guaranteeing concentricity between the shaft and the insert itself.
4. Every AeroInsert-H (AIH) inserts boast Double Shoulder Technology (DST, US Patent # 8337342), which was adopted from our now discontinued AeroInsert-D (AID) to allow [1] an increase of total gluing surface area for a carbon inner tube and [2] a decrease in flex during the launch cycles of an arrow.

## Conclusion

Take the 0.204" ID shaft for example. [1] What is the ID of your arrow? As given, it is 0.204" which is between 0.200" and 0.230," which means all styles are half-outs. [2] What material would you like? Well, here, there are three options for material: aluminum ("A"), stainless steel ("S") and titanium ("T"). And finally, [3] what technologies? i.e. do you want to take advantage of only Reverse Tapered Shoulder Technology (AeroInsert-A) or Reverse Tapered Shoulder Technology as well as Double Shoulder Technology (AeroInsert-H)? In the case of AeroInsert-A, you are ultimately left with a simple decision: which material? On the other hand however, for AeroInsert-H, there are two decisions. For besides material, there is also an option of the type as well as length of carbon inner tubes (CTI) used i.e. 4.6gpi (AIH2Lx/CTI20L) or 8gpi (AIH20x/CTI200).

**Remember:** Even after using these questions to guide you, the most important inquiry is what do YOU want your arrow's final impact to be? Consider not only the individual properties of each decision but the accruing ones as well. Which will you choose?

# BROADHEAD SUMMARY

With the addition of the Stalker, we felt that our broadhead series also deserved a summary to help customers in their purchase decisions. Note that more details can be found about each product line on their own respective pages.

## Introduction

After the launch of Aerovane in 2007, we kept hearing that broadheads did not fly well with it. This is because Aerovane is airfoil-based, meaning that the faster the arrow flies, the faster it will spin due to circular lift. And as the speed of archery projectiles only continues to get faster, broadhead technology hasn't held up. Whether projectiles are fletched with Aerovane or not, a higher degree of aerodynamic efficiency is required.

## The Traumahawk

Traumahawk, as the first and only blunt force trauma broadhead available on the market, has an edge instead of a point. If one looks closely, the front of the Traumahawk is an exact replica of a large drill bit tip. This design is meant to harness the excessive force that a modern crossbow gives out. According to our research, it only takes about 25lb KE for an arrow with a well-designed broadhead to pass through a typical full-grown North American white-tailed deer. Today's high speed, high power crossbow however, easily exerts more than 130lb KE, over four times more power than required!

With so much extra energy being wasted, it made sense to develop a broadhead that would transfer as much of that energy as possible. That broadhead is Traumahawk. We found that due to its efficiency, Traumahawk transfers about 90lb KE to a target in the same conditions. Note however, that Traumahawk is *mostly* only effective as a broadhead when equipped on high speed, high power projectiles. The only exception is as a small game head.



## The Dagger Series

After the launch of Traumahawk, we received several customer requests to create a similar broadhead but with less use restrictions. The answer was Dagger. While we wanted to maintain its high energy efficiency, Traumahawk's initial edge required too high of a minimum speed/power. So, we compromised with a point and added another, smaller bevel. This multi-single bevel design requires less energy to penetrate while still being a solid, one-piece design with the majority of its weight on the outer perimeter—still encouraging gyro spin.

## The Phenomenon of Cavitation

During testing for Traumahawk, something very unusual happened. After a closer look at the game harvested from Traumahawk, we noticed some sort of pink foam had collected around the impact sight. With some research, we learned what we had stumbled upon: cavitation.

Cavitation is the interesting natural occurrence of small vapor-filled cavities (bubbles) wherever there is rapid changes in pressure. This pressure change occurred because of Traumahawk's dual cavities. While we originally added them to keep the weight of the broadhead on the outside, we learned that at high speeds, those cavities had an additional effect: the formation of a low pressure zone.

With the opportunity to further adjust and perfect the Dagger's design due to Metal Injection Molding, we decided to add a rounded, airfoil like edge to the inside of the same dual cavities. This unique and patent-pending design takes advantage of our broadhead's high rotation, high energy efficiency and optimizes it for the cavitation process, especially when used in tandem with Aerovane II/III. Now, when the MIM Daggers pass through a high oxygen-enriched organ like a lung, cavitation will force oxygen to be released from the blood, and foam is formed. Animals will expired quickly as normal breathing becomes extremely hard, if not impossible. Game will drop within sight, making blood trail moot.

## The SwingBlades and Stalker SwingBlades

SwingBlade was designed because we were given a design challenge: a broadhead that could fly [1] on an Aerovane 3 fletched shaft, [2] in 35mph plus crosswinds, [3] at 550fps, [4] without the need to broadhead tune, and [5] with accuracy. It seemed an impossible task. Traumahawk and Dagger already checked four of the five requirements, but a broadhead that didn't need practice? It was unheard of; you can't just screw your field point off your arrow before a hunt, install a broadhead, and expect success! At least, until SwingBlade.

SwingBlade, being a mechanical broadhead, still has a legal cutting diameter of ~3/4" closed. Unlike other mechanical broadheads however, the three blades operate independently. Each blade has two single bevel grind surfaces, on their front and their back. This design ensures that the blades will only engage when it makes contact with the target. That way, SwingBlade will fly just like a field point.

Note that the two newer, larger SwingBlade blades, Talon and Saber, still meet the above requirements but with speed limitations i.e. archery projectiles should not exceed 315fps for Talon or 300fps for Saber.

In January of 2021, Firenock was issued our 41st US patent on a new insert that uses a stem system that offered an alternative to AeroOutsert for 0.166" ID size shaft. Utilizing AeroStem Technology and one of the two new Stalker SwingBlade bodies (in stainless steel or aluminum), you can take full advantage of SwingBlade.

For late summer 2022, the AeroStem system will also launch for the Dagger broadhead in stainless and 100 grains.



# FACE THE F.A.C.S.

Firenock LLC started as a lighted nock company in 2006. Since then, there have been thousands of combinations of Firenock lighted nock systems alone. But we are not just a lighted nock company, and we have not been since 2007 with the introduction of the Aerovane. The last forty or so pages of this catalog detail that. With Firenock, of course, along with AeroBushing, Aerovane II & Aerovane 3, AeroWeave, SportWeave, AeroOutsert, AeroInsert-A, Carbon Inner Tubes, AeroInsert-H, AeroPoint, AeroConcept Points, the Destroyer Series, SwingBlade, the Stalker Series, Stalker SwingBlade, Dagger, Stalker Dagger, and Traumahawk, we've more than covered an arrow from end to end. But then, with so many products, how do you know which ones works for you?

For the past fifteen years, Firenock's online presence has evolved along with the growth of e-commerce. Today, the world arguably shops more online than they do in person. That is why, this year, we are proud to announce that firenock.com and our webstore, shop.firenock.com, are finally one and the same! Customers can now learn all about our products and purchase them in the same place. The Firenock Arrow Component Selector, or F.A.C.S. for short, proudly sits front and center. To find it, simply click the first tab on the navigation menu, "Component Selector." We've also compiled some hints below to help you glean the most out of your selection.

The F.A.C.S. was designed to be as intuitive of a webapp as possible. There are just two plus one steps to get to your arrow's Firenock products.

1. Choose your arrow manufacturer from the first drop-down. Note that we do not make components for every arrow from every manufacturer. However, if your arrow is made by a different manufacturer than those listed, please contact us to double check if we have a modification method that would work for you.
2. Next, select your arrow's model from the second drop-down. Make sure that you have the exact name because some manufacturers have series of the same title with only slight differences e.g. Carbon Express's Maxima Hunter, Maxima Hunter KV, etc.
3. In the case of crossbow arrows, a third drop-down will appear. To get the correct Firenock lighted nock system recommendation especially, it is crucial that the exact crossbow intended for use is selected. For example, with the "D," "D2," and "D3" nock styles, they have slight but significant differences. All three nocks have the same 0.165" serving at the nock throat but while "D" has a 0.298" ID, both "D2" and "D3" have a 0.300" ID. Further, while "D" and "D2" have long prongs, "D3" has short prongs to avoid contact with certain triggers / anti-dry-fire (ADF) systems.
4. After results populate, an image of the correct arrow will appear as well as some of its specifications like spine, OD, GPI, etc. Double check these details for the best match.
5. The arrow components list itself offers helpful information including high resolution images of every applicable item as well as a direct link to their specific product pages.

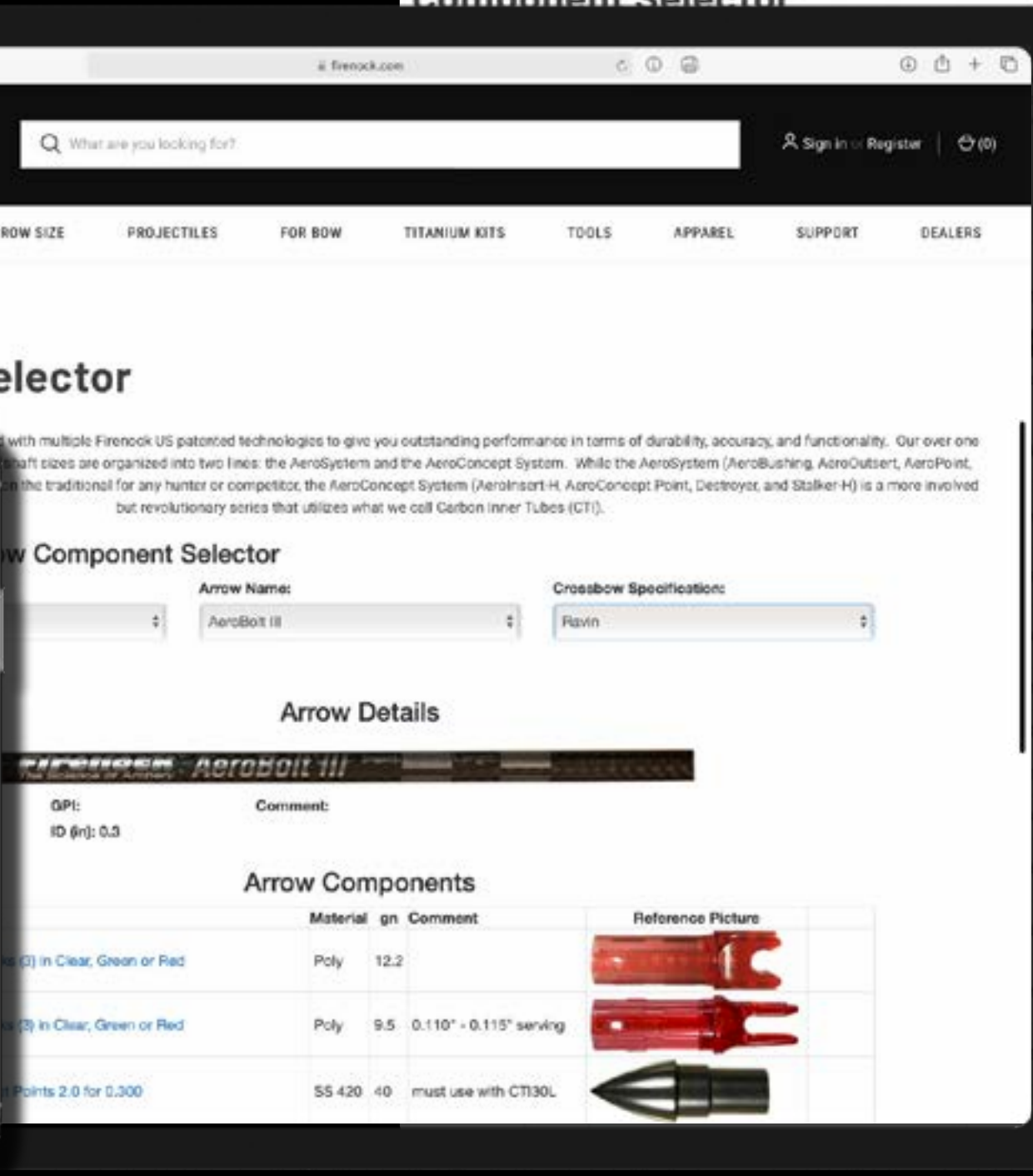
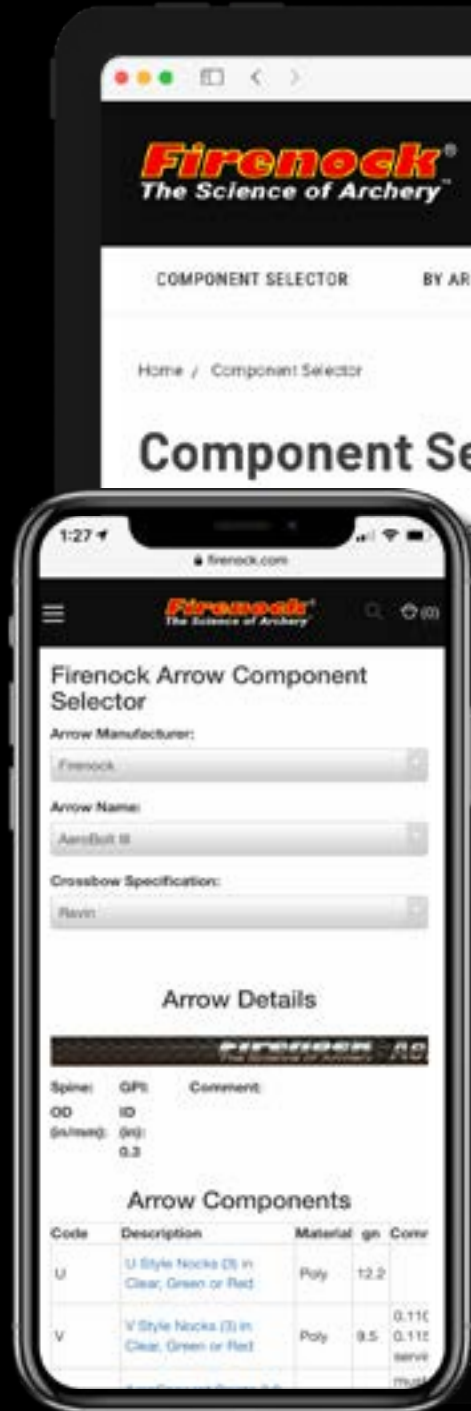

COMPATIBLE WITH ALL DEVICES

# BOW ACCESSORIES Overview

3

Firenock is known for its arrow components but we've been making vertical bow and crossbow accessories for over a decade. We believe that every variable matters. Whether your goal is to hit the eleven ring every time or get that trophy buck, our goal is to help you make sure it happens. From cam to cam or limb to limb, Firenock bow accessories include comprehensive upgrades like our titanium fastener kits to fresh takes on traditional accessories like stabilizers (AeroStab). Since 2018, we've also compiled dedicated pages for the most popular crossbows and companies like Ravin, the PSE TAC, Scorpyd, and as of this year, TenPoint.

## Titanium Upgrade Kits

### Give Your Bow That Extra Boost



While its light weight is utilized for a 45% reduction in weight, titanium's rigidity is the less known but more significant characteristic. Although admittedly acknowledged and employed for years, Firenock correctly apprehends the application of titanium within the archery sphere. With such rigidity, overall vibration is minimized, leading to the consumption of excess energy. Why might you want to have excess energy absorbed? With all the rustable, heavy fasteners replaced with titanium ones, your bow will shake less and shoot flatter. Learn more and discover your kit at [firenock.com/titanium](http://firenock.com/titanium).

## AeroBump™

### The Z-bar Sting Stop

Vibration, like sound, travels linearly. Our titanium Z-bar is designed, as its name suggests, in a patented "Z" shape, with double 91 degree turns, to reduce any residual vibrational energy. Further, this unique shape also allows the rubber bumper to be closer to the center of the bow, where there is the highest magnitude of play. The AeroBump's Z-bar is available in four size ranges, and adaptors like the Bow Riser Threaded Insert and the 3/8" Aluminum Collar ensure maximum compatibility.



## AeroStab™

### Diminishing Vibration, the Hidden Enemy

While standard stabilizers counteract the weight of all of the different types of accessories available today, they do not also counteract the vibrational energy output from high-performance bows. After firing, shock returns to your bow due to Newton's third law. Therefore, the AeroStab stabilizer utilizes titanium instead of aluminum or carbon for optimal vibration dampening. Completely interchangeable with over ten connection pieces for endless possible configurations, this series still weighs up to 80% lighter and costs up to 40% less than what is on the current market.

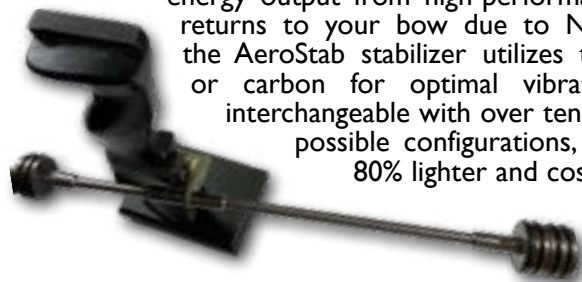

## Ti LimbSaver® Broadband

Reduce the sound and vibration of your bow with the Titanium-upgraded LimbSaver Broadband. These dampeners are extremely useful and could be the very thing that saves you in a hunt, allowing you to take an extra shot. They respond over the audible frequency from 20 Hz to 20,000 Hz, meaning they stop high-end and low-end vibrations. Easy to install in minutes and applicable to both vertical bows and crossbows, this comes in a set of two.



## AeroRest™

### The Fully Contained, Frictionless Rest

Each AeroRest is equipped with three custom supports that house ceramic ball bearings that act as the arrow's 96-degree contact points. CNC precision processed and built with materials like titanium and aircraft aluminum, we believe AeroRest is one of the lightest and most accurate rests on the market. It is available in over ten models suitable for most vertical bows and popular crossbows like the PSE TAC and all Ravin models.

An arrow's null point or node should match the arrow rest. For a rail-less crossbow like the Ravin, check out the ARRAMI, the Micro-Adjust AeroRest for Ravin, which boasts three versus two axes of adjustment.

## Ravin® Pulley & Cable Kit

Designed to bolt onto your bow with zero modifications, this kit replaces all four Ravin factory cables with two custom stainless steel parts, four titanium screws, and two new cables. This upgrade self-times the upper and lower cables, virtually eliminating cam lean. Additionally, the stress from syncing up and keeping all four cables from twisting is reduced.



## The Picatinny System

### Adapting Gun Standards for Crossbow

Currently, there are two track options to cover all Scorpyd® Crossbows. While the one designed for the 2016-18 styles comes with two titanium screws to fit the barrel perfectly, the one for DeathStalker comes with only one due to the style's lack of a protruded riser. We added a trigger block to this latter version to compensate. A Picatinny Rail upgrade requires the removal of the factory trigger guard and, therefore, also requires the purchase of the companion upgrade, the Skeletonized Aluminum Trigger Guard. This system also includes an adaptor for the ACAD and an optional foregrip made with glass-filled nylon and titanium hardware.



## AeroCrank-AD™

### The Truly Silent, Infinite Ratchet System

Loaded with two independent patent claims and 17 dependent patent claims, the AeroCrank series truly re-thinks every part of how a crossbow crank should and has worked. Taking advantage of an anti-anti-reverse slide-switch system, the AeroCrank-AD (ACAD) at its heart is a 300lb system that houses four titanium and five carbon drag washers. With a 3:1 gear ratio, this vigilant design far exceeds any big game fishing reel systems currently available. The ACAD is a one-for-one replacement of the TenPoint® ACUdraw to mount permanently. For efficient installation, we recommend purchasing the ACAD on stock or with a mounting accessory, like the Picatinny Rail Mounting Bracket or the Quick Exchange Mounting Plate. To store the AeroCrank handle, the Quick Release Handle Mount, which involves a compression versus torsion spring, is sold separately.



# TI UPGRADE KITS

Firenock has offered customized titanium upgrade kits since 2014. We believe that every bow on the market will benefit from the upgrade. Therefore, we designed and developed the T.U.K.S., or Titanium Upgrade Kit Selector, to help customers quickly find the perfect kit for their bow. And, if you don't see your bow in the dropdowns, please contact us! We are constantly adding to and updating our database.

The screenshot below is an example of what the TUKS looks like in action. After selecting a bow manufacturer, year, and model, every fastener on that bow will be listed including each screw or bolt's OEM (original equipment manufacturer) versus new titanium weight.

**Search Bow**  
 Manufacturer: Mathews | Year: 2020 | Bow(s): VXR 31.5

**Bow Details:**  
 Mathews | 2020 | VXR 31.5

Net Inc.	Description	Imp	Count	OEM	Ti	Picture
	Limb Bolt	1	2	500	199.8	
	Cam Stop Screw	2	2	13	6.16	
	Cam Mod Screw	2	4	12	7.10	
	Axle End Screw	3	4	13	6.10	
	Limb Tip End Screw	4	8	20	11	
	Limb Tip Plate	4	4	39	31	
	Limb Pocket Screw	5	2	57.5	32.4	
	Limb Pocket Bottom Screw	5	4	24	12.7	
	Cable Rod End Screw	7	2	19	11	

**Fastener Count Summary:**  
 Fastener Count: 32  
 Not Offered: -0  
 Arrow rest: 1  
 Sight: 3  
 Package Count: 36  
 OEM (gr): 1691 | Ti (gr): 514.8

**Annotations:**  
 - "Imp" stands for "Importance," as in how significant of a change a titanium update will make. The lower the number, the less important.  
 - Check the top number here to learn the total number of fasteners, including arrow rest and sight screws.  
 - Click this button to be sent directly to a bow's specific titanium upgrade kit page.

# TI UPGRADE KITS

Our kits replace your bow's original heavy and rustable bolts, screws and cam stops with titanium ones. All the components within the Titanium Fasteners Upgrade Kits are made up of high-grade titanium with the highest desired accuracy and are about half of the weight of the factory ones (or even a third in the case of our titanium hollow fasteners). Also, for any fasteners that are in need of an extra boost, we have them custom made.

- Your bow will look new even after hunting in the harshest environments as titanium will never rust.
- Your bow will become lighter, especially while you are holding your bow with your arm out straight.
- Your bow will vibrate less as heavy focus masses are replaced by significantly lighter ones.

When purchasing Titanium Fastener Upgrade Kits, you can choose from two options: the Basic Kit or the Advanced Kit. The Basic Kit always includes limb bolts, sight screws and arrow rest screws. The quantity of each is according to your preference during checkout. The Advanced Kit, on the other hand, includes most to all of the bolts, screws, cam stops, and other specialty parts on your bow. You can discover if we have a kit for you using the Titanium Upgrade Kit Selector, or TUKS. If your bow is not in our database, you can always contact us so we can try our best to build a kit for your favorite bow.

## Cam Stops (US Patent: 9,097,486)

Firenock currently has seven different designs of cam stops (right). Each boasts two or more of the forthcoming features. To start, all six exploit titanium by utilizing its properties of lightness and rigidity. Examples of this exploitation include increasing their diameter but decreasing their wall thickness to ultra-thin. Due to this special design, our cam stops weigh 80%+ lighter than factory. Another unique design detail used for some of our cam stops is a wider base, which increases the contact surface between the cam stop and the cam, thus minimizing the chance of cam deformation due to high pressure during tightening and pull back (and again, because of the properties of titanium, the extra materials used to make that base won't effect the weight too much). Lastly, arguably the most important feature is our use of O-rings. See, instead of the use of a sleeve of rubber on the cam for dampening, all Firenock titanium cam stops utilize multiple O-rings (no less than five). Continuously moving along their cam stops, these O-rings can and will never deform or crack.

With the installation of Firenock titanium cam stops, your cam will become lighter which not only increases the rotational speed of the cam, but also decreases the torque stress that is applied to the cam at each launch cycle. In short, your bow will become more stable, balanced, and efficient while your arrow will achieve a higher launch speed and point of impact (POI).



## Sample List of Custom Bow Parts

- Barrel Nut for 3/8"-16
- Bowtech Carbon Riser Limb Bolt
- Bowtech Hollow 3/8"-24 x 2 1/4" Bolt
- Bowtech Mating Limb Pocket Hold Set
- Bowtech Undercut Head 5/16"-18 x 2" Bolt
- Button 3/8"-24 x 3/4" Hollow Screw
- Button 5/16"-24 x 3/8" W1/2" Hollow Screw
- Cable Guard Bearing Long Shoulder Screw
- Cable Guard Bearing Short Shoulder Screw
- Expedition/Obsession Cam Stop
- Extra Heavy Duty Cam Stop with Screw
- Flat 3/8"-24 x 3/4" Hollow Screw
- Flat 5/16"-18 x 2" Hollow Bolt
- Flat 5/16"-24 x 3/4" W1/2" Hollow Screw
- Flat Dome 3/8"-24 x 2" Hollow Bolt
- Large Hollow Cam Stop
- Mid-width Cam Stop
- Mission Hollow Axles
- PSE 2.78" Hollow Limb Pocket Bar
- PSE 3.08" Hollow Limb Pocket Bar
- PSE 3.28" Hollow Limb Pocket Bar
- PSE 3/8"-24 Barrel Nut
- PSE Cam Stop with Screw
- PSE LAS™ Barrel with Side Control
- PSE LAS™ Side Control Nut
- PSE Old Style Quiver Hollow Screw
- PSE TAC 15 Elite Cable Guard
- PSE TAC 15i Hollow Cable Guard
- Ravin Hollow Axles
- Slim Cam Stop with Screw
- Socket 5/16"-18 x 2 1/4" Hollow Bolt
- 5/16"-24 x 3/4" Hollow Stabilizer Stud
- 5/16"-24 x 1" Hollow Stabilizer Stud
- 5/16"-24 x 1 1/2" Hollow Stabilizer Stud
- 5/16"-24 x 2 3/4" Hollow Stabilizer Stud



These scales show an complete sample factory kit's weight in comparison to a one-to-better Titanium Upgrade Advanced Kit's weight (1379.7 vs. 794.0 grains).

# AEROREST™ The Fully Contained, Frictionless Rest

AeroRest is believed to be the most advanced and most accurate rest on the present market. Proudly designed in the state of Illinois, each AeroRest is equipped with three supports housing ceramic ball bearings that act as the arrow's 96 degree contact points (US Patent: 8,875,687). CNC precision processed and built with materials like titanium and aircraft aluminum, we believe AeroRest is one of the lightest and most accurate rests on the market.

AeroRest is initially similar to other full containment arrow rests on the market, but after a closer look at the technical design, you can discover how unique it truly is.

## Three Fingers

Designed to achieve the smallest contact surface physically possible, the AeroRest boasts virtually no friction while shooting. But how can it execute such a feat? The answer is material science. On a circle or sphere, the plane that touches its curved surface is called a tangent. And that "plane," at least on a material as exceptionally hard as ceramic, is actually a point. With two or three fingers having one point of contact each, our AeroRest still remains a full containment system.

## Ceramic Ball Bearings

Each support is topped with a sphere or ball. With the ball bearings being made of ceramic, one of the hardest materials in the world, the tangents or points of contact are even smaller—the roundness is ensured. Under these first ball bearings in each of these supports is another ceramic ball bearings, making a total of six ball bearings. And under all those ball bearings is a spring, therefore three springs total. With this two ball bearings and spring design, you can fine adjust the suspension system of each support to perfectly match the flex of your arrow, making you shoot faster, straighter and more accurately.

## Magic 96 Degrees

For AeroRests with a cock vane down design, between the two lower fingers, there is exactly 96 degrees of separation. This perfect amount of separation allows the AeroRest to shoot ultra-slim, slim and standard arrows—shafts with an OD or outside diameter from 4mm to 12mm—with only three simple setup steps described in the manual.

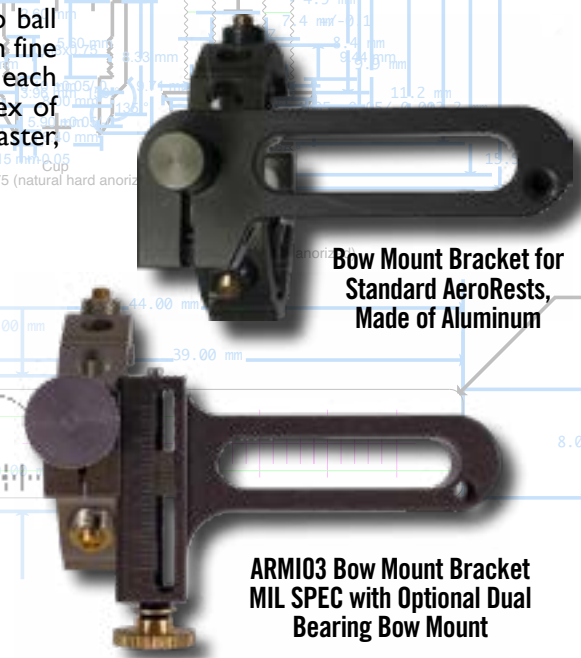
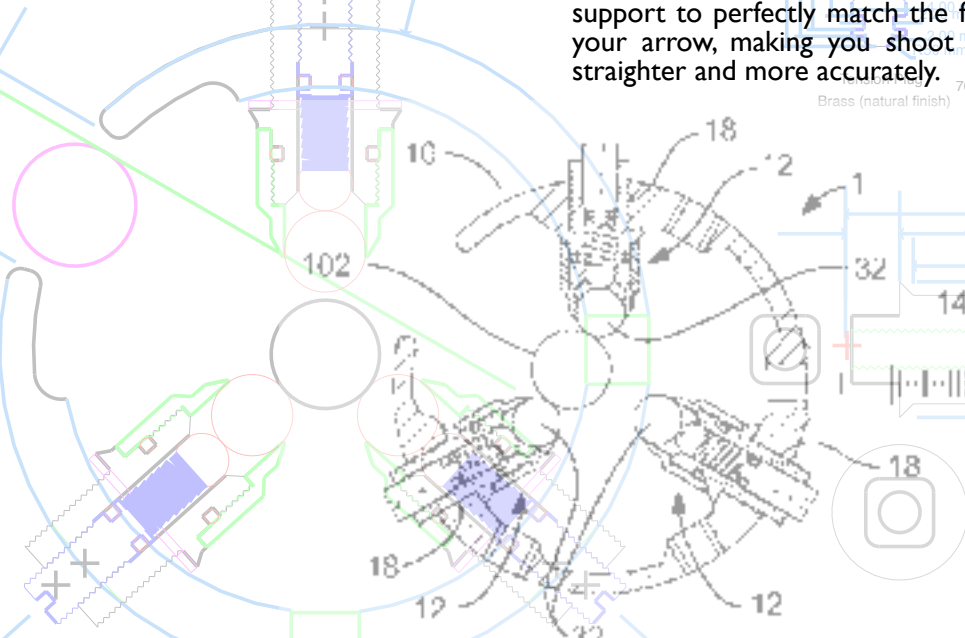

## Top 10 AeroRest Features

1. Frictionless Shooting : Ceramic contact surface eliminates almost all friction between the arrow and the rest itself.
2. Fully Contained System : Three fingers ensure that your arrow is always contained within the rest.
3. No-Wear Surface : Industrial grade ABEC#5 ceramic ball bearings mean perpetual roundness and smoothness.
4. Camouflaged Sound : Each of the three arrow supports are loaded with two ceramic ball bearings suspended by a beryllium copper spring to provide smooth operation. During draw and launch, the produced sound replicates that of hard wood being rubbed.
5. Super Lightweight : AeroRest is about one ounce as a result of the usage of new generation materials like ceramic and beryllium copper.
6. Premium Finish :The major components of the AeroRest are type three anodized for durability and for its natural olive green color.
7. Premium Additional Components : Spacers are made of GR5 Titanium. All additional fasteners are made of GR2 Titanium. Overall making them 45% lighter than ordinary steel materials and completely non-corrosive.
8. Versatile : AeroRest can be altered with spacers to accept arrow shaft sizes as small as 0.156" to as large as 0.365". Further, with the removal of the top support, AeroRest can accept arrow shaft sizes as large as 0.45"
9. Optional Micro-Adjustable Design : For even more adjust-ability, the Micro Adjustable AeroRest has a built-in micrometer to enable very fine adjustments (0.1mm) during target shooting or during in-field hunting (see next page.)
10. Left & Right-hand Shooter Friendly : The AeroRest frame was designed with universality in mind and has port holes around its entire circumference to mount the sidebar.

# The Standard & Micro-adjust Series AEROREST

There are two main vertical versions of AeroRest: Standard and Micro-adjust. There are also two sub-versions of the Standard AeroRest, the only difference between the two being their sidebars. Learn more about our AeroRest lineup and how they expand past the traditional arrow rest design below.

## The Standard Series

ARST00 is made from 7075-T5 Aluminum, finished with a Type II Level 3 anodization, and is laser marked with guidelines. The ARST0H, on the other hand, boasts a GR5 Titanium sidebar that is machined to be hollow. Although titanium is more expensive, due to the lack of finish, both sidebars (and therefore both AeroRests) are the same price. Additionally, since 2017, both Standard AeroRests come with a new, longer bow mount to allow the use of two AeroRest mounting screws for stability, reliability and to eliminate the need for set screws.

## The Micro-adjust Series

Firenock Micro-adjust AeroRest (MAAR) utilizes the same C-frame as the standard AeroRest. Thus, all that is great about the Standard AeroRests apply to the two Micro-adjust sub-versions. The MAAR's ability to micro-adjust is US patented (US Patent: 8,967,133). But what is so special about it? The answer lies in MAAR's capacity to adjust both vertically and horizontally at the same time with only one fastener. Further, because both axes are based on a vernier scale micrometer, when we say "micro," we mean possible visible adjustments as fine as 0.1mm per direction.

MAAR can be installed onto nearly any vertical bow in the market via its three options of side bars. The shortest one can extend up to 15mm from the AeroRest mounting surface, while the longer one allows another 10mm for a total of 25mm of extension from the AeroRest surface. This longer side bar has proven to accommodate bow risers with a sight window portion as thick as 1.25". Due to thicker risers like those on Mathews bows with an integrated sight mount, an even longer 1.75" side bar is also available. ARMI03 is the latest model, which has its bow mount equipped with two ball bearings, allowing one to swap the position of the knob from top to bottom easily. This version also has a third ball bearing at the base of the horizontal knob for even more precise adjustments.

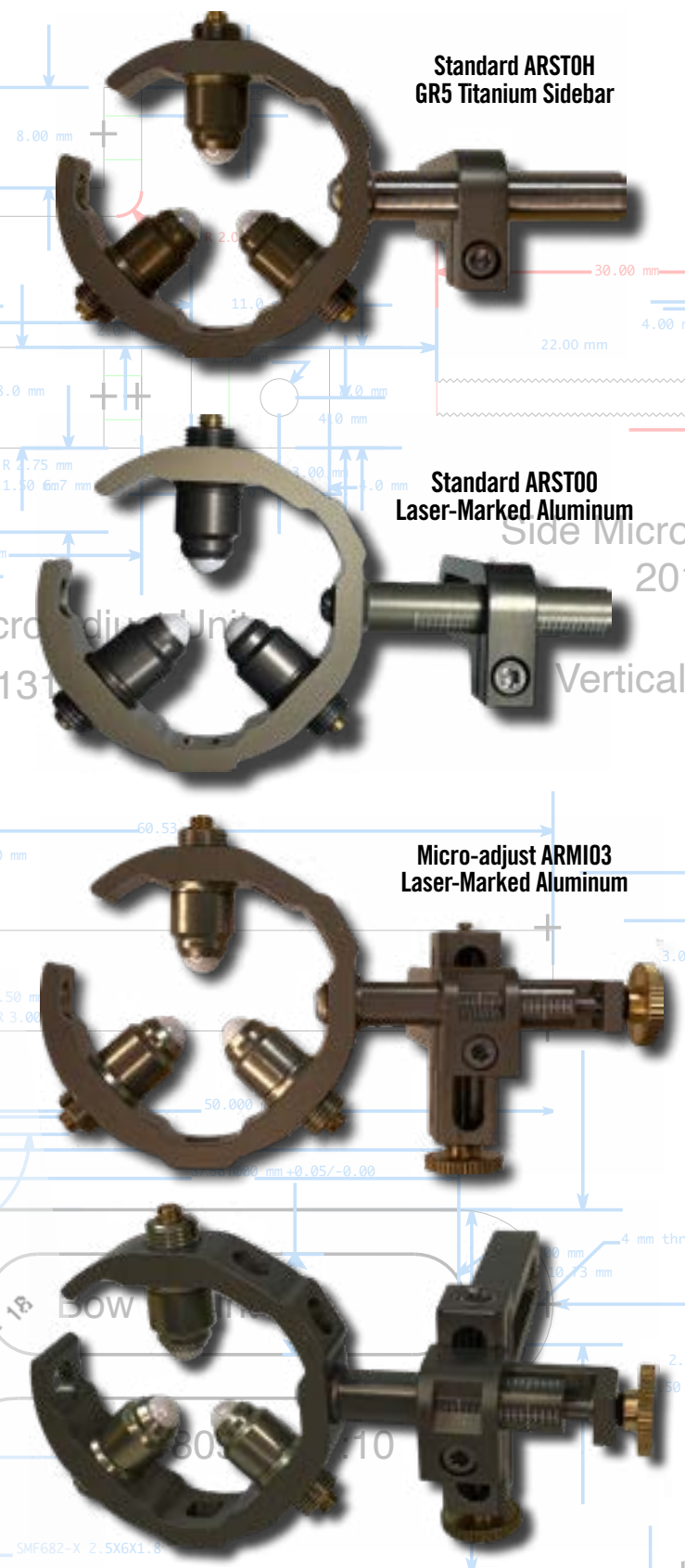

# AEROSTAB The Components

If we had one sentence to explain why the AeroStab was so unique, the forthcoming one would be it. Completely interchangeable and able to counteract both the weight and the vibrational output of your bow, this series still weighs up to 80% lighter and costs up to 40% less than what is on the current market.

## “Completely Interchangeable”

Unlike traditional stabilizer systems that offer components of all different sizes and shapes, every piece of the Firenock AeroStab Series is based around several connection pieces. Including a bow mount, a front connection, as well as multiple elbows and couplers, the possibilities are endless. See the next spread for examples of ways to configure the connections. But, of course, a stabilizer involves more than just connection pieces. Currently, this series includes six extension bars in two materials with four weights, all able to mate with these connection pieces.

Note that, for those who are not ready to or do not wish to adopt the full AeroStab system, alternatives are available. Specifically, with the use components like the 1/4”-20 to 5/16”-24 titanium thread adaptor (AST4CO) and 1/4”-20 weight adaptor (ASTWBU), one can mix and match elements of standard stabilizers they already own with select AeroStab ones.

## “Counteract Both Weight and Vibration Output”

Though the AeroStab’s ability to consume the vibration output of a bow was already heavily discussed in “The Theory,” the weight stabilizing facility involved was only briefly mentioned. We’ll do better now.

As aforementioned, mechanically, the most commonly used device for stabilizing the weight of a bow is a bow balancer. This tool is what we intend consumers to use to balance the weight output of their bows. There is a common problem that occurs during that process however—the capacity to make precision adjustments. While other stabilizer mounts involve simple connections like teeth or dimples, each of our connection pieces has a special O-ring that allows for precise, controlled adjustments at multiple angles. Further, with the use of multiple connection pieces, there is an option for compound angles for even more exact adjustments.

The key lies in how to mate all and any of these pieces together. Currently, there are two methods of tightening. For most connection parts, there is a custom made hollow GR5 Titanium button head screw (5/16”-24 x 3/8” OD W0.5” ASTHBS) that can be torque-tightened with a T40 driver. When even more torque is necessary, we also offer GR2 Titanium washers (ASTTIW) for a 40% increase. Lastly, for the coupler connections that need to be tightened upon, two 12mm slots are machined on their barrels if a wrench needs to be anchored and utilized.

## “80% Lighter” & “40% Cheaper”

For perspective, a standard Hunter Class stabilizer system with a 6” sidebar and a 12” front bar can be as heavy as 22 oz. Of those 22 ounces, only four are actually for weight stabilization; the rest is just the extension bars and elbows to position the weights. On the other hand, replicating the exact configuration of one short and one long extension bar, all AeroStab pieces, besides the weight(s), will weigh less than 5 ounces. And the best part of it all, due to their simplicity (i.e., every piece is maximum only machined and then laser-marked), the entire system will go for much cheaper than standard. Do not let that “simplicity” fool you, howbeit. As with all things proudly from the Firenock lineup, from Dorge’s mouth, “everything that could be considered has been considered.”

To learn more about the AeroStab, visit <https://www.Firenock.com/aerostab/>



# Connection Pieces & Kits AEROSTAB

All of the different connection pieces of the AeroStab system can be confusing to differentiate. To assist, we’ve collected and organized all eight below for your convenience. Note, on the far right, the additional two crossbow adaptors (ASTCBS for 5/16”x24 systems & ASTCRP for Picatinny systems) and below them, the new ASTSAD that allows for Firenock hollow titanium stabilizer bars to be mated to most manufacturers’ mounts and/or quick release systems (5/16”x24).



The AeroStab stabilizer is designed with extreme flexibility and compatibility in mind. Below are a few kits that we pre-configured to show how the system can be used to give you the winning edge in the field.

### A typical one-sided AeroStab stabilizer configuration kit will consist of:

- 1-AST515
- 1-ASTBSM
- 1-ASTBSS
- 1-ASTFMQ
- 2-ASTELB
- 1-AST40B
- 1-AST23B
- 1-ASTQRP
- 1-AST4B3
- 1-AST4B2
- 2-ASTW40
- 2-ASTW20
- 2-ASTW10

### A typical two-sided “V” bar AeroStab configuration kit will consist of:

- 1-AST515
- 2-ASTBSM
- 1-ASTFAM
- 1-ASTFMQ
- 2-ASTELB
- 2-ASTELQ
- 1-AST70B
- 2-AST23B
- 3-ASTQRP
- 1-AST4B3
- 1-AST4B2
- 1-AST4B1
- 2-ASTW40
- 3-ASTW20
- 2-ASTW10

### A one-sided competition AeroStab configuration kit will consist of:

- 1-AST515
- 1-ASTBSM
- 1-AST510
- 1-AST40B
- 1-AST23B
- 1-AST4B3
- 1-AST4B2
- 1-ASTW40
- 2-ASTW20
- 2-ASTW10



To learn more about the AeroStab, visit <https://www.Firenock.com/aerostab/>

# AEROBUMP The Z-bar String Stop

# The Lineup AEROBUMP™

What do string stops look like today? In terms of material, a good string stop involves some light weight structural material connected to a piece of rubber. Examples of that "lightweight structural material" include a bent rod made of aluminum or a straight rod/tube made of graphite or carbon. And, finally, usually, those rods/tubes are attached to one's bow by one or multiple set screws. None of these characteristics apply to the AeroBump.

Now that we know what string stops are usually like, its important to understand that the main problem that arises with traditional string stops can be described in one word: vibration. The cause of this problem however, is multi-faceted. The table below attempts to organize how and why vibration is precipitated and how the AeroBump can alleviate or even completely eliminate that vibration.

	Problem	Solution(s)
<b>Material</b>	Aluminum, graphite, and carbon, common string stop materials, all have a high vibrational energy transmission rate. This means that during launch, most excess energy will be transferred right back to the riser.	The Z-bar of AeroBump is made entirely of a solid, machined piece of titanium. Titanium, unlike any other regularly available materials, consumes instead of transfers energy. While carbon is known to transmit 99.95% of vibrational energy, pure titanium consumes up to 80%.
<b>Shape</b>	The bent or straight shape of most string stop bars do little to nothing to mitigate the vibrational energy output of the string stop to the bow.	Vibration, like sound, travels linearly. Our Z-bar is designed, as its name suggests, in a patented "Z" shape with double 91 degree turns (US Patent # 10215521). These turns reduce any residual vibrational energy after the majority was consumed by the titanium. Further, this unique shape allows the rubber LimbSaver bumper to be closer to the center of the bow, where there is the highest magnitude of play. <i>Note: It is crucial for the AeroBump to be swung towards the true center of the bow string to be most effective. Further, the bumper itself can and should be rotated to accommodate for the minor offset from the bow string's vertical center as well.</i>
<b>Length</b>	There is no universal string stop attachment location. Manufacturer to manufacturer, even bow to bow, anchor points can be anywhere, requiring different lengths of string stops. Without an ensured contact point, vibration cannot be managed.	The AeroBump's Z-bar is available in four sizes: 3.5" - 4", 5" - 5.5", 6.5" - 7", and 8.0"-8.5". Note that the sizes are ranges because the Z-bars will ultimately be threaded inside the riser as well as inserted within the bumper. GR2 Titanium also has the same relative softness as brass and, therefore, allows for further length modifications. The optional sloped GR5 Titanium hex nut should cover any exposed threads to give the system a finished look.
<b>Installation</b>	The fasteners used to unite the rod/tube of the string stop with your bow amplify the vibrational energy output because they act like a stylus or focal point for energy to build.	All AeroBump Z-bars are machined with industry-standard 5/16"-24 threads, removing the necessity for any fasteners. For bows with a 3/8" straight hole, we offer the aluminum collar adaptor for a clean connection.
<b>Adaptability</b>	Bow risers do not all have 5/16"-24 threaded holes. In some cases, there are even no threads at all.	Although the AeroBump series is recommended for use without fasteners, two adaptors are available to suit such cases. The custom GR5 Titanium bow riser threaded insert, for example, has an 7/16" OD and a 5/16" ID. This insert can be machined into a solid bow riser for a clean connection. The custom 3/8" aluminum collar, on the other hand, does not involve machining and can be added to the Z-bar for use with set screws then cut to a specific, desired length.

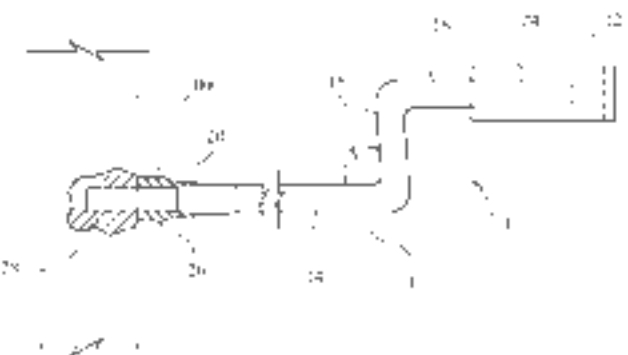

The AeroBump is a revolutionary bow accessory that takes advantage of advanced materials like GR2 Titanium and the patented physical properties of a Z-bend to technically minimum string stop vibration up to 99%. For maximum efficiency, the AeroBump must be fitted properly to your bow.

AeroBump bars come in four different lengths, each of which has 1.5" / 38mm of 5/16"-24 thread at the riser connection end. Different forms of string stop anchors may require additional accessories, which is why different lengths and configurations will end up at different prices.

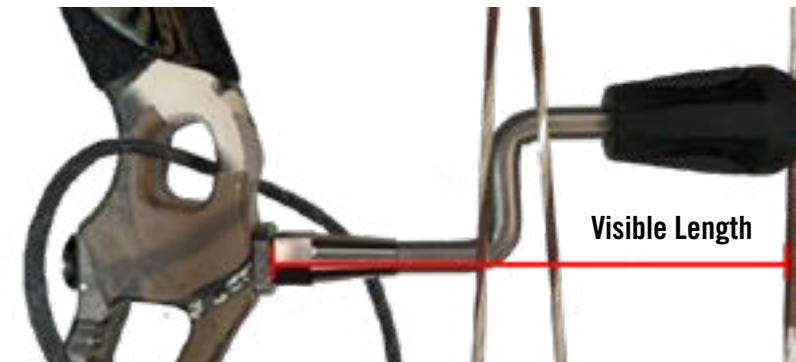

To select the perfect AeroBump configuration for your setup, follow the steps below.

1. Measure the "visible length" or perpendicular distance from the riser to the string stop (see image to the left).
2. Select a matching "String Stop Length (Visible)" from the online dropdown within 1/4".
3. Using a standard arrow rest screw (5/16"-24 screw), investigate what type of string stop connection you have on your riser. Your "String Stop Hole Type" could be one of three options:
  - If it is a 5/16" Straight Hole, secure AeroBump with factory set screw(s).
  - If it is a 5/16"-24 Threaded Hole, secure AeroBump with added Hex Titanium Nut.
  - If it is a 3/8" Straight Hole, fit with added Aluminum Collar and secure AeroBump with factory set screw(s).

**Adaptors**  
GR5 Titanium Hex Nut  
5/16"-24 ID



**AL Collar Adaptor**  
3/8" OD



**GR5 Titanium Insert**  
7/16"-20 OD,  
5/15"-24 ID



**String Stops**

ABZS40 (4" / 10cm)



ABZS55 (5.5" / 14cm)

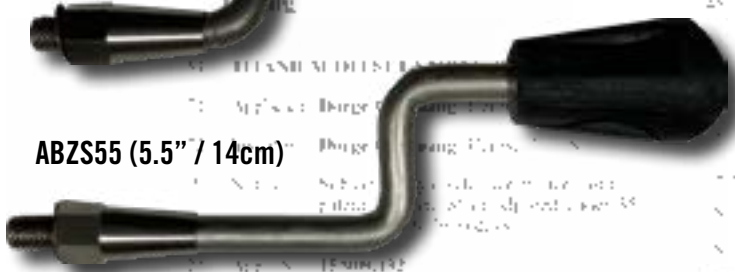

ABZS70 (7" / 17.8cm)



ABZS85 (8.5" / 21.6cm)



# RAVIN Crossbow Series Upgrades

# AeroRest RAVIN

The Ravin crossbows, loved by many, leave a lot of room for customization, optimization, and upgrades. For all current series (R9, R10, R15, R20, R26, and R29), we offer many accessories including Aerobolt, Titanium Kits, Firenock, and the Pulley & Cable Kit.

Firenock Ravin/Center Point Specification Table	R9	R15	R10	R20	R26	R29	R29x	R500	R5x	R10	R10x	CP400
Year Introduced	2017	2017	2018	2018	2019	2019	2020	2020	2022	2022	2022	2019
Factory Suggested Arrow Length	20"	20"	20"	20"	18"	20"	20"	20"	20"	20"	20"	N/A
Required Arrow Length with ARRAVO/1/2	21"	21"	20"	21"	20"	21"	21"	-	21"	20"	20"	N/A
Required Arrow Length with ARRAVM	≥21"	≥22"	≥21"	≥22"	≥20"	≥22"	≥22"	-	≥22"	≥21"	≥21"	N/A
Firenock Titanium Kit	Y	Y	Y	Y	Y	Y	Y	-	Y	Y	Y	N
Firenock Titanium Hollow Axle Kit	Y	Y	Y	Y	Y	Y	Y	-	Y	Y	Y	Y
Firenock Nock Style with 0.134" Center Serving	U	U	U	U	U	U	U	U+	U	U	U	U
Firenock Nock Style with 0.124" Center Serving	C	C	C	C	C	C	C	C+	C	C	C	N
Ravin String Length	29"	29"	29"	29"	28"	29"	29"	-	28"	29"	29"	29"
Twin Cable Pulley System Length (Standard)	20 1/8"	20 1/8"	19 3/8"	20 1/8"	18 7/8"	20 1/8"	20 1/8"	-	18 7/8"	20 1/8"	20 1/8"	20 1/8"
(Recommended: longer but with less stress)					19 5/16"				19 5/16"			



## AeroBolt

All Ravin crossbows, with the exception of the R10, and R26 (20"), require a minimum of a 21" projectile. With the use of a Ravin AeroRest however, that minimum changes. In addition, we suggest a 22" projectile.



The Firenock AeroBolt Series (II & III) crossbow arrows can be cut down to any length and thus can be used on any Ravin crossbow. Additionally, all AeroBolts, at purchase, can be built for a 2, 3 or 4 vane configuration. For those who want to use the Ravin for ultra big game, the AeroBolt II Dragon Slayer is also available.

Note: Like all common crossbow arrows on the market, the internal diameter of all AeroBolts is 0.300" for simple and easy nock style and crossbow exchanges.

## Titanium Kits

As mentioned on previous pages, titanium accounts for a minimum of a 50% reduction in weight. Learn more about the benefit of its ultra rigidity in reference to a bow's overall vibrational energy on page 58.

## Titanium Axles Kit

An option available at purchase of a Titanium Fastener Upgrade Kit for Ravin are our custom hollow titanium axles. Why should you purchase a kit? Well, consider this—your cam is the focal point of the kinetic energy being exerted on your crossbow and at 400+ fps, there's a lot of that energy to go around. With our upgrade, our kit alone would reduce close to 420 grains in moving mass.

## Firenock

Firenock offers a total of 21 nock styles. Of those, five are well-suited for serving sizes often found on crossbows such as Ravin. As always, to ensure that the system will shoot correctly, it is necessary for the nock to clip onto the string perfectly. For any Ravin crossbows which boast a 0.133"-136" OD serving, the "U" series are the best option. The "C" series are for those with a 0.125"-0.128" OD serving.

Like many of our Firenock styles, "C" and "U" are offered in a plethora of colors. With three options for color of nock and six options for color of LED, there is a total of 18 color combinations for each style. Additionally, there are up to three different functions of light (solidly lit, solidly lit for 6 seconds and then blink, and auto shut-off after 17 seconds).

The new 500 Series (R500/E) features an acute string angle and higher power which can deform plastic nocks. The aluminum "C+" (for ~0.127" OD serving) and "U+"/"U+5" (~0.133" OD serving) solve this issue. Plus nocks take advantage of our patented Square in a Circle Technology for concentricity and available in orange and green.

Disclaimer: Firenock does not make nocks for Ravin crossbows. All Firenock nocks are and have always been designed to fit specific IDs and ODs. Please check and double check the exact fit of your nocks or bodily harm could occur.

## Pulley & Cable Kit

Last year, after Firenock ventured into custom upgrades for the Ravin Crossbow Series, one of the main requests from users was a solution to the Ravin cable stretch issues. Our licensing and production of this double U.S. patented Pulley & Cable Set Kit is our response.

This kit utilizes two US Patents owned by Scopyd Crossbows and licensed by Firenock (US Patent # 9,243,861 and 9,234,719). Designed to bolt on with zero modifications to your bow, the full kit replaces all four of the Ravin factory cables and involves two custom 420 Stainless Steel 53 HRC hardened parts, four titanium screws, and two cables.

There are many fantastic benefits to this dual US patented design. Most significantly, the upper and lower cables are self-timed. This means that cam lean is virtually eliminated as cable length differences are the main culprit of cable stretch. Additionally, the stress from working to sync up and keep all four cables from twisting is significantly reduced. Note finally that as cable length increases, shock absorption does also, leading to an ultimately quieter bow. Disclaimer: This kit does not include any Ravin authorized parts. Therefore, note that you may lose your factory warranty if you choose to install this set within the first five years of original purchase. However, like all Firenock products, you have our 30 days no-fault warranty, exchange, and refund at purchase from our webstore.

## Kits include

- 2 x Stainless Steel pulleys
- 4 x GR5 Titanium 10-24 screws
- 2 x cables
- 1 x string (optional)

Ravin crossbows have become known for taking a lot of effort to tune and maintain. In some cases, the plastic rollers on the factory rests can and will wear out to the point of disuse. In many cases, especially when one wants to use an arrow over 500 grains, the Ravin factory rest falls short. The AeroRest: RAVs are our solution.

## Standard Ravin Series

The AeroRest for Ravin (ARRAVI), as with all AeroRests, utilizes our patented tangent system which means there is no more than 0.000,000,8" of square surface area constantly in contact with the shaft. As the total contact surface area between AeroRest and the shaft is tiny, friction is infinitely little while still full contained.

Design-wise, the ARRAVI is simply a standard AeroRest with a rectangular frame instead of a C-frame to fit at the front of a Ravin. The mounting holes are even identical to the OEM Ravin Rest. But we, of course, supply custom titanium screws and copper spacers. These additional components allow for easier and smoother rest position adjustments during tuning. This version is equipped with a simple water leveler at the top of the frame.

AeroRest for Ravin II (ARRAV2) boasts all the benefits of the AeroRest for Ravin. What then, is the difference? It is the cutout that allows one to be able to still view the water leveler while using a scope (US Patent: 10,458,743). This helps a shooter ensure just before release that their bow is level, which is especially important particularly considering the short axles on a Ravin.

Another feature of the cutout is that it aids during close range shooting. Most crossbows with a high powered scope find it difficult to swiftly reconfigure their lens when game spontaneously appears in close range. Due to its position just beneath the water leveler, the cutout acts as a close range aiming assistant.

For those who prefer no water leveler on the rest, ARRAVO is ARRAV2 without the water level and priced the same as ARRAVI. And new for 2024, for those who want the option to choose the standard, an elevated or to have no water leveler, the ARRAVI.1 is available for a small up-charge.



## Micro-Adjust Ravin Series

It is essential for the null point or node of an arrow when being shot to match up with the arrow rest. For those who wish to follow this rule, especially where a rail-less crossbow like the Ravin is involved, the ARRAMI, the Micro Adjust AeroRest for Ravin, is finally here.

ARRAMI is our first and only adjustable AeroRest that has three axes of micro-adjustment (US Pat. 10,415,924). Specifically, the vertical and horizontal axes are controlled via our single screw fastener found on the original Firenock Micro-adjust AeroRest (US Patent: 8,967,133) while the longitudinal axis is controlled via a new unit consisting of a single locking screw as well as a long threaded screw to ultimately optimize the arrow's node position.

This arrow rest allows an adjustment of about 1.5" for lengthwise movement. Therefore, based on the broadhead and field point used, one can precisely adjust the location of the arrow rest. Note that although Ravin factory arrows are 20" in length, we at Firenock suggest the use of at least a 21" arrow to take full advantage of the Micro Adjust AeroRest for Ravin.

Finally, like the ARRAV2, this rest is equipped with a water leveler that is beneficial for both stability and close range aiming. In this case, however, the leveler is actually vertically adjustable, meaning that those who use high power optics can ensure that the water level sits perfectly at the bottom of view even if the angle is narrower.

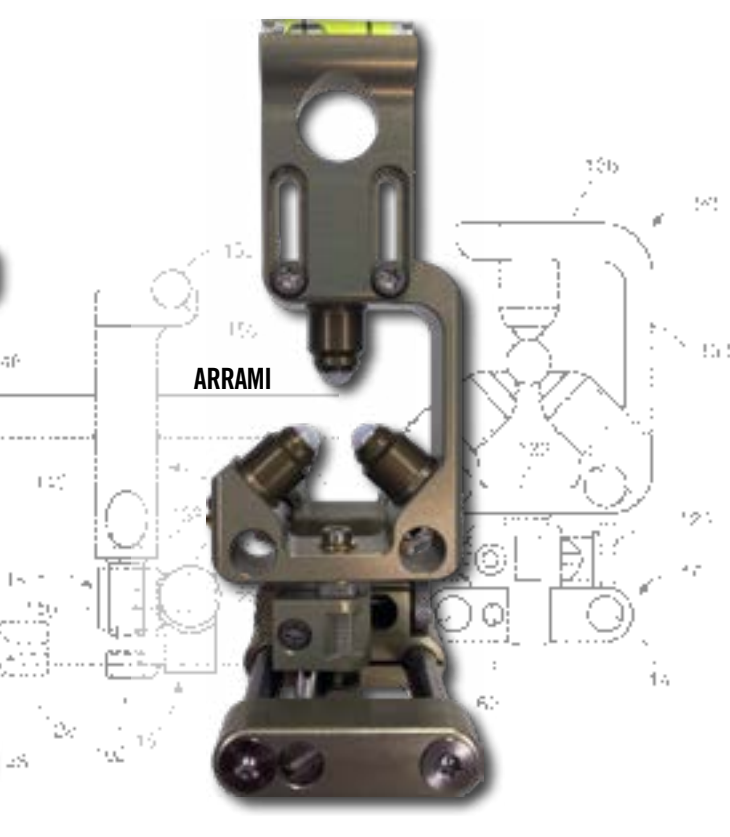

# AEROCRANK™-AD The Silent Crossbow Crank

The TenPoint™ ACUdraw™ is one of the most popular add-on crossbow cranks on the market. After hearing from our customers, however, we learned that current owners have some concerns. Learn about our solutions to those concerns via the AeroCrank-AD (ACAD) below.

## Concern #1: Dangerous While De/Cocking

### Solution #1: Anti-Anti-Reverse System

The AeroCrank-AD is a compound machine involving an instant anti-reserve system and a simple slide-wedge (US Patent # 10421637). Specifically, the ACAD has a full size 12mm x 16mm one-way clutch bearing; a huge 35mm x 7mm drag drum support bearing; a 6mm thrust bearing; and two ball bearings for shaft support. These custom parts ensure control during both de/cocking operations.



The one-way clutch bearing is press-fit perfectly inside an octagonal housing. This piece allows the anti-reverse system to be totally disengaged via the slide-wedge, as shown above. At disengagement, this combination becomes an anti-anti-reverse system, allowing the main shaft to turn freely.

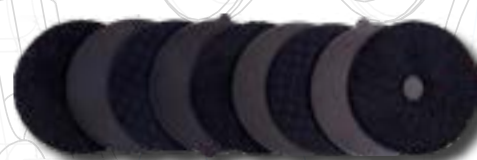

Independent and dependent from the systems above is the heart of the AeroCrank-AD: a 500lb drag system that houses four titanium and five carbon washers. All nine drag plates are smothered with DuPont™ Krytox®, a pure PTFE EP grade lubricant. The tri-star drag knob manually and safely releases the friction pressure from this powerful drag system to de-cock any AeroCrank-AD crossbow.

Drag Driver Assembly

## Concern #2: Heavy Weight & Bulkiness

### Solution #2: Body Skeletonization

To make it lightweight, all parts of the crank are CNC machined with maximum skeletonization in mind. All parts that will be stressed and require extra strength have fasteners and parts made of GR5 Titanium for absolute long-term durability and good looks. The main body of the ACAD is made out of 7075-T5 Aluminum, which boasts 80% of the strength of stainless steel but only a fifth of its weight. Both the left and right sides of the body weight in at only four ounces each.

## Concern #3: Challenging Installation

### Solution #3: Pre-Installed Out-of-the-Box

AeroCrank-AD was developed to be a one for one replacement of the TenPoint ACUdraw and meant to be permanently mounted onto a crossbow. Note that although designed for efficient installation, we recommend purchasing the ACAD on stock. Another option, of course, is getting the ACAD set up at a Firenock Certified and Trained Dealer.

## Concern #4: Clutch Longevity

### Solution #4: Drag Pressure Release

It is advised to relax the drag/clutch unit before long-term storage to avoid binding drag plates to the main shaft. To do so, one should hook the sled onto the string, then fully relax the drag/clutch via the tri-star drag knob and start cranking forward on the handle. When the handle can be cranked ahead while the sled does not retrieve at all, the clutch is fully relaxed. Make sure to park the sled on the string only. It is critical to correctly and fully relax the drag/clutch before long term storage or drag seizure/frozen drag may occur.

## Concern #5: Removability

### Solution #5: Mounting Accessories

Firenock offers two accessories to upgrade the ACAD to a removable crank: [1] the Picatinny Rail Mounting Bracket (see below) and [2] the Quick Exchange Mounting Plate (see TenPoint spread). Available at purchase pre-installed or sold separately.

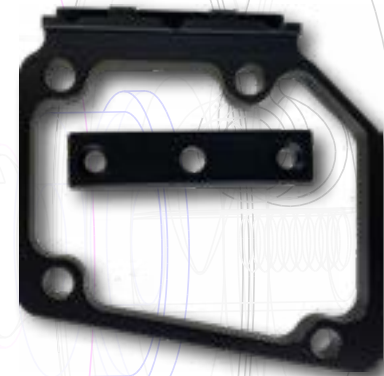

The AeroCrank Quick Release Handle Mount (see below) was developed to store the handle anywhere on a crossbow stock. Made of durable POM nylon and accompanied by GR5 Titanium fasteners, the entire mount weights 0.5 oz/14 grams. Installation requires drilling two 3/16" holes one inch apart in your stock.



# Crossbow Series Upgrades SCORPYD

Over the years, several factory Scorpyd crossbow components have left space for upgrades and customization. Some accessories we offer for this series include the AeroBolt, Firenock, Picatinny Rails, Picatinny Trigger Guard, Picatinny Folding Foregrip, Titanium Kits, AeroRest (via a custom adaptor), and AeroCrank-AD.

## AeroBolt

The Firenock AeroBolt Series (II & III) crossbow arrows are an original factory option at purchase for any Scorpyd crossbow. For those who want to use the Scorpyd for ultra big game, the AeroBolt II Dragon Slayer is also available.

Note : Like all common crossbow arrows on the market, the internal diameter of all AeroBolts is 0.300" for simple and easy nock style and crossbow exchanges.

## Firenock



Firenock offers a total of 21 nock styles. Of those, two cover all current styles of Scorpyd series crossbows. Since the beginning of the Firenock x Scorpyd collaboration almost a decade ago, the "Q" nock has been standard.

When the Scorpyd DeathStalker was introduced in 2018 however, we learned that the standard "Q" nock (0.145" OD throat) was not suitable. For with this style's semi-rail-less system and the "Q" nock's slightly larger throat, there was nothing to guide the arrow after a certain point. Therefore the "U" (0.135" OD throat) was utilized to solve this need.

Finally, like all of our Firenock styles, "Q" and "U" are offered in a plethora of colors. With three options for color of nock and six options for color of LED, there is a total of 18 color combinations for each style. Additionally, there are up to three different functions (solidly lit, solidly lit for 6 seconds and then blink, and auto shut-off after 17 seconds).



## Picatinny Rails

The first custom upgrade to the original foregrip is the tactical track rail. There are two options available to cover all Scorpyd series crossbows.

Both rails consists of a full rail that covers the entire front lower part of a Scorpyd crossbow and also boast a 5/16-24 thread hole for those who are looking to put a stabilizer system on their decked-out crossbow.

The differences between the two options are that those for the 2016-18 styles come with two titanium screws to fit the barrel perfectly (see back and front images above) and weight only 1.7 oz, while those for the DeathStalker only come with one due to the style's lack of a protruded riser. Also, due to this lack, a trigger block was added to the Deathstalker version (see bottom image above)

Note : Due to the fact that both Picatinny Rail upgrades require the removal of the factory trigger guard, the purchase of a custom Firenock Skeletonized Aluminum Trigger Guard is required as well.

## Picatinny Trigger Guard

The Skeletonized Aluminum Trigger Guard is the second custom upgrade for the original Scorpyd crossbow. The companion piece to both tactical track rails, this guard is not only good looking, but also weighs only 1.2 oz.

## Picatinny Folding Foregrip

This foregrip is the third and final custom Picatinny upgrade. Made light weight with glass-filled nylon, it is 4.6 oz. All hardware is made of GR5 Titanium. Designed to be used on the Picatinny rails, this foregrip can be installed where comfortable under the crossbow barrel.

## Titanium Kits

All Scorpyd crossbows come standard with titanium fasteners installed.

## AeroRest Adaptor



With the introduction of crossbow cranks, the need for even more accuracy via the control of an arrow rest become evident. Since Scorpyd crossbows also use the standard cock vane down configuration as the Ravin crossbows, with our AeroRest adaptor, they can be equipped with any of the AeroRest: RAV arrow rests. Learn more about these rests on the AeroRest spread.

## AeroCrank-AD

AeroCrank-AD is designed, patented, and manufactured exclusively by Firenock. The Picatinny Rail Mounting Bracket is a perfect way to install the ACAD on a Scorpyd crossbow.

# PSE TAC Crossbow Series Upgrades

The PSE™ TAC crossbows, though now discontinued, are still many an archer's go-to. To supplement and optimize your favorite crossbow, we offer many accessories including AeroBolt, Firenock, AeroRest, Titanium Kits, and upgraded Cable Guards.

## AeroBolt

The TAC10 crossbow needs a 24.25" projectile and for the TAC15, 15i, Elite, and Ordnance crossbows, a 26.25" projectile. Custom-built, the Firenock AeroBolt Series (II & III) crossbow arrows can be cut down to any length and thus can be used on any PSE TAC crossbow. Additionally, at purchase, all AeroBolts can be of 3 or 4 vanes (i.e. TAC specific "bow-tie" configuration to clear the scope rail). For those who want to use the TAC for ultra big game, the AeroBolt II Dragon Slayer is also available.

*Note : Like all common crossbow arrows on the market, the internal diameter of all AeroBolts is 0.300" for simple and easy nock style and crossbow exchanges.*

## Firenock



Firenock offers a total of 18 nock styles. Of those, two are well suited for the TAC Series Crossbows. As always, to ensure that the system will shoot correctly, it is necessary for the nock to clip onto the string perfectly. For all TAC crossbows which boast a 0.165" OD serving, "D" and "D2" are the best options. Between the two, the only difference is the required arrow shaft ID and therefore the arrow that you decide to use along with our lighted nock system. To be more specific, "D" has a 0.298" ID, which fits the PSE TAC factory crossbow arrows, while "D2" has a 0300" ID (which perfectly matches AeroBolts, for example).

For those who decide to use the Firenock with TAC factory arrows, it is important to note that the process of installation is a little more involved than usual. Due to the fact that TAC factory arrows come with basic components already installed via glue, it is sometimes harmful and in some instances impossible to remove them. Nonetheless, for those who decide to try to remove the original components and succeed, please install a Carbon Express CXL 250 bull-dog collar. For

often, even when one is able to clear the back of the arrow, it can become flimsy and cause the Firenock to shuffle into the shaft and ultimately destroy both the shaft and the Firenock itself.

Finally, like all of our Firenock styles, "D" and "D2" are offered in a plethora of colors. With three options for color of nock and six options for color of LED, there is a total of 18 color combinations for each style. Additionally, there are up to three different functions of light (solidly lit, solidly lit for 6 seconds and then blink, and auto shut-off after 17 seconds).

*Note : The new cousin of "D" and "D2", the "D3" nock, is NOT compatible with this series due to its shortener prongs.*

## AeroRest

Many who had used the PSE TAC crossbows for long range precision shooting understand it takes a lot of effort to tune one. A specific problem that arises is that, unfortunately, because of the short-lived nature of the factory rest, accuracy suffers as the rest wears. Fortunately however, due to Firenock's patented three-fingered AeroRests' core material being ceramic, wear is not an issue.

Due to its unique design, all projectiles using AeroRest (ARTAC0) on a TAC crossbow must have a three vanes configuration with cock vane up. Due to this requirement, some alterations must be made to the crossbow. Particularly, 1.75" of the scope rail must be cut off. Then, due to the now very short scope rail, an optimizer (e.g. HHA) must be purchased and installed. A photo of this entire setup [minus the AeroRest] is shown below.



## Titanium Kits

Here, while its light weight is indeed utilized for a 50% reduction in weight, titanium's rigidity is the less known but much more significant characteristic. Although admittedly acknowledged and employed for years, the application of it within the archery sphere has only been correctly apprehended by Firenock. See, with such rigidity, overall vibration is minimized which leads to the consumption of excess energy. Why might you want to have excess energy absorbed? Because then your bow will then shake less and shoot calmer. Learn more about this concept on the AeroStab spread.

## Cable Guards



For those who love the PSE TAC but are unhappy with how the two main cables can rub against each other, we at Firenock now offer a solution. Our Cable Guard Upgrade Kit replaces the clunky factory aluminum cable bumpers with two custom-designed GR5 Titanium bars, two LimbSaver string stops, and two nylon cable rollers. This system minimizes cable wear and friction (with up to 5fps gain), and is also lighter than what the factory offers.

# Crossbow Series Upgrades TENPOINT

TenPoint and Wicked Ridge crossbows are currently on the rise. This year, we're dedicating a page in the catalog to this series. Accessories we offer include AeroBolt, Firenock, and AeroCrank-AD (via an custom adaptor).

## AeroBolt

The Firenock AeroBolt Series (II & III) crossbow arrows can be cut down to any length and thus can be used on any Scopyd crossbow. Additionally, all TenPoint, at purchase, can be built for a 2, 3 or 4 vane configuration. For those who want to use the TenPoint for ultra big game, the AeroBolt II Dragon Slayer is also available.

*Note : Like all common crossbow arrows on the market, the internal diameter of all AeroBolts is 0.300" for simple and easy nock style and crossbow exchanges.*

## Firenock



Firenock offers a total of 17 nock styles. Of those, two cover all current styles of TenPoint Series Crossbows.

As always, to ensure that the system will shoot correctly, it is necessary for the nock to clip onto the string perfectly. For almost all TenPoint crossbows, which accept a 0.155" serving size, the "J" nock style is recommended. For the new Nitro 505 and any other 500fps plus model, however, the D3 is more suitable. At such a high speed and power, the serving capacity should be slightly larger than 0.155" serving (0.165"). Both "J" and "D3" have short-pronged designs to accommodate for TenPoint's anti-dry-fire systems.

Finally, like all of our Firenock styles, "J" and "D3" are offered in a plethora of colors. With three options for color of nock and six options for color of LED, there is a total of 18 color combinations for each style. Additionally, there are up to three different functions of light (solidly lit, solidly lit for 6 seconds and then blink, and auto shut-off after 17 seconds).

## AeroCrank-AD

The AeroCrank-AD was created as a one-to-better replacement for the TenPoint ACUdraw. To install either onto the crossbow stock, a mounting plate is required. The current mounting plate is made of plastic and is not compatible with the AeroCrank-AD. The Quick Exchange Mounting Plate is made of 6061 Aluminum and can be installed with factory fastening screws.



Original Plastic TenPoint ACUdraw Mounting Plate



Firenock AeroCrank-AD Quick Exchange Mounting Plate



## Crossbow Nock Fit

With the release of an over 500fps crossbow this year, crossbow nock fit matters more than ever.

In reality, crossbow nock fit has mattered since day one. Cams, or more specifically limbs, are never perfectly synced. Full-railed crossbows, the most common crossbow, help guide a bolt down the rail by adding down pressure via a bow string and/or an arrow retainer. Manufacturers notably equip factory bolts with half moon/crescent or flat nocks to take advantage of this accuracy while remaining cost-effective. Firenock, however, recommends clip-on nocks for all types of crossbows to achieve a higher level of accuracy and safety. But what throat size and fit condition work on full-railed, rail-less, and semi-rail-less crossbows?

For a full-railed crossbow, a nock should fit loosely (0.002" to 0.005" of slack). As aforementioned, accuracy will suffer if the nock is too tight and premature sting wear will happen. We define a semi-rail-less crossbow as one where the only point of rail contact after launch is the front of the rail. A rail-less crossbow is one where there is no rail, and therefore the only point of contact at launch is the arrow rest. With this understanding, without a rail to guide the bolt, both semi-rail-less and rail-less crossbows require tight nocks that move with the bow string to guarantee consistency (0.003" to 0.007" of compression).

# PREPARATION TOOLS *Overview*

You only have one shot. Make it count by preparing your bow and arrow the best you can with the best there is. The Firenock preparation tools lineup includes Arrow Chamfering Tool (ACT), AeroBowString Serving Jig (ABSSJ), Arrow Preparation System (APS), Professional Arrow Preparation System (PAPS), and Aerovane Jig.

## Arrow Chamfering Tool (ACT)

Attach the ACT to any drill, place your arrow at the center of the tool and run the drill (~1500 rpm) for approximately three seconds. Immediately after, your arrow is ready to mate with the Reverse Tapered Shoulder of a Firenock AeroInsert-A or an AeroInsert-H. The ACT is made of steel and its grinding surface is diamond silver electro-plated. Available in 100 (coarse) or 180 (medium) grit.

## AeroBowString Serving Jig (ABSSJ)

Often when strings are served, there is [1] an inconsistency in pressure and [2] a lack of pressure. Together, these issues cause servings to go oval or pear-shaped. ABSSJ, then, is designed to handle the high volume, high demand, and high tension process of string building that requires consistent, extreme pressure (as high as 26 LbF versus the average of 1.25 LbF) for an extended period of time. Similar to high-performance fishing reels, the ABSSJ has a nine-element drag system that allows for no less than 400% higher serving tension than most jigs without any loss of control.

## Arrow Preparation System (APS)

Usually, arrow reparations procedures include using several different tools at different times. With APS, you can prepare arrow shafts prepared in both a time and space-efficient manner. A 6-in-1 tool—[1] nock end squaring tool, [2] insert end squaring tool, [3] fletched nock end squaring tool, [4] broadhead/field point spin checker, [5] outsert concentricity checker, and [6] general spin checker—APS is truly engineered with our customers in mind. Once you try APS, we believe that you will discover how essential a tool it is for precision arrow building.

## APS Super Spinners

Due to the radius being, on average, five times greater than that of an arrow, the flange ball bearings of the Super Spinners will spin once before your arrow spins five times. Spin-checking has never been more simple. Sold separately.

## Aerovane® Jig

Aerovane Jig is an advanced piece of equipment designed for perfectly fletching and re-fletching vanes and is the only jig that can unleash the full potential of the Firenock Aerovane. Like other Firenock products, Aerovane Jig can be customized with multiple genuine Firenock accessories to fit your needs. A selected list of such accessories includes the Aerovane Jig fixed chucks, which are tapered and precisely machined to ensure zero play, and the Aerovane Jig slide hooks, which are fitted with ball bearings for smooth offset operation. The optional Laser Alignment Module allows for re-fletching accuracy up to 1/4-1/16th of a degree. This laser can also be added to the PAPS with the Mounting Module.

## Aerovane® Clamp

Though initially similar to other magnetic-based clamps, the Aerovane Jig Clamp is machined with a straightness of at least 0.001." Our clamp has two ABEC#5 ceramic ball bearings installed for smooth operation, precision, and durability for the pivot point. Finally, with two 1/16" bars machined into its body, this clamp is the only one on the market that can successfully fletch Aerovane.

## Professional Arrow Preparation System (PAPS)

A unique take on the ordinary arrow preparation tool, the PAPS acts as your arrow's spine index, i.e., first dynamic bend, locator. Why is locating that "index" important? After finding the bending point of your arrow, you can use it as a reference point for your cock feather. By doing so, you can then control how every one of your arrows will flex during launch because they will all flex in the same direction.

The PAPS includes [1] the tower, which provides the perfect perpendicular contact points with a shaft, [2] the track, which simplifies measurement with easy-to-read tapes, and [3] two supports, which, with their unique crowned outer edges, solves uneven and pinch pressure problems. Check out the Vibration Module to amplify the first dynamic bend or the Digital Gauge Module to measure deflection quickly.





# AEROVANE GLUE AG0600, AGOGEL, & AGUSSE

Firenock offers three specially formulated and contained adhesives for today's archers to fletch vanes and build arrows with truly excellent results.

## Aerovane AG0600

To perfectly fletch Aerovane and other vanes, Firenock specially formulated AG0600.

Curing in nine seconds and ready to shoot in twelve, AG0600 is best used for fletching Aerovanes or other vanes with the use of the Firenock Aerovane Jig and the Aerovane Clamp at room temperature. As a standard, AG0600 comes with our industrial grade, high precision Luer-Lock System, which allows you to dispense glue precisely and accurately.

Custom built, the bottle is specifically designed for ease during both holding and squeezing, and the applicator, with a 22 gauge stainless tip, is also removable and replaceable. See the Additional Notes for recommendations, tips, and warnings.

## Aerovane AGOGEL

AGOGEL is best for installing Firenock Extreme Shock End Caps, re-fletching Aerovanes or other vanes, and fletching offset configurations.

AGOGEL is perfect for filling gaps and has a very quick dry time. AGOGEL is a single component cyanoacrylate instant super glue gel, resulting in the bonds AGOGEL makes with most surfaces with gaps up to 0.2 mm in diameter happen in seconds. AGOGEL, like AG0600, contains no stabilizer and unlike AG0600 has a low viscosity, which allows it to be able to be applied in tricky places that require glue to not flow (e.g. re-fletching a surface that is not perfectly flat).

AGOGEL requires no mixing or heating and can be used on a wide variety of materials. Each package comes with three 24-gauge plastic Luer-Lock applicator tips. See the Additional Notes for recommendations, tips, and warnings.

## Aerovane AGUSSE

AGUSSE is best for building Firenock Aero-System and AeroConcept System arrows which involve AeroInserts, AeroOutserts, Carbon Inner Tubes and other components.

AGUSSE is a two-part epoxy that allows for a work time of about 90 minutes and will cure in 24-36 hours when at room temperature. It can fill gaps up to 1mm and has the ability to flex even when cured. See the Additional Notes for recommendations, tips, and warnings.

### Additional Notes

1. AG0600 and AGOGEL are not mixed with stabilizer and so only have a shelf life of only one year after manufacture.
2. All Aerovane glues are 100% dissolvable in acetone.
3. All Aerovane glues should be stored when not in use within their original containers, at room temperature, and out of direct sunlight.
4. Luer-Lock tips are one time use only. Extra Luer-Lock tips can be purchased separately in 12-packs.



To learn more about our glues, visit <https://www.Firenock.com/glue/>

# Arrow Preparation System APS

Firenock designed APS to resolve the imperfections and shortcomings of the various current arrow preparation tools on the market. Today, in order to consistently build reliable arrow shafts, there are several preparation procedures that one must complete before continuing to installation and assembly. Usually, these preparations include the use of several different tools at different times—a squaring tool for both sides of the arrow before and after fletching or a spinner to make sure your shaft is concentric, for example. With the Arrow Preparation System (APS), arrow shafts can be prepared in both a time and space efficient manner (US Patent # 8608531). A 6-in-1 tool—[1] nock end squaring tool, [2] insert end squaring tool, [3] fletched nock end squaring tool, [4] broadhead/field point spin checker, [5] outsert concentricity checker, and [6] general spin checker—APS is truly engineered with our customers in mind. We believe that, once you try APS, you will discover how essential a tool it is for precision arrow building.

## Special Features

### Adjustable Roller Track Base System

To guarantee that the APS can be used to square any length arrow or type of fletching, a unique track base system was developed. Involving up to four rollers, the system allows the user to change their position by simply loosening their lock screws, moving left or right, and locking them again.

### Never Wear Grinding Service

Made of a solid piece of aluminum that is hand anodized for durability, the APS grinding block is different from any other arrow preparation tool because of its longevity. Recommended with the use of common 3M adhesive back sand paper (cut into 1x1 inch squares), APS's grinding surface is interchangeable. If the sand paper is worn out, just replace it and you have a fresh grinding surface again. The APS grinding block is made from a solid piece of aluminum and then hard-anodized for durability, so there is no worry about the straightness of the block even after sticking and removing sand paper from the block repeatedly.

### Supports with Custom Ball Bearings

Since 2015, the crowned ball bearings designed for the PAPS (the Professional Preparation System) have been adapted to suit the APS. The bearings provide a larger support surface and allow for smoother operation, even under high pressure. The large size of the crowned ball bearings also eliminate any lateral movement, especially while squaring. Sealed for durability and pre-fitted with mounting screws, these supports eliminate all play.

### Super Spinners

Spin-checking has never been more easy. Due to the radius of the Super Spinners being, on average, five times greater than that of an arrow, the flange ball bearings will spin once before your arrow spins five times. By literally making the bearings work less, Super Spinners allow you to take complete advantage of our unique bearings.



To learn more about the APS, visit <https://www.Firenock.com/aps-tool/>

# PAPS The Professional Preparation System

# Optional Modules PAPS

Firenock PAPS is proudly designed in Illinois (US Patent # 9046452). A unique take on the ordinary arrow preparation tool, the PAPS acts as both your arrow's spine index (spine index = first dynamic bend) locator as well as your arrow deflection value (with optional digital gauge) tool. With PAPS (and some practice), you can easily do all complicated, but important arrow preparation procedures within seconds.

## Why Do YOU Need PAPS?

After locating the bending point of your arrow, you can use it as a reference point for your cock feather. By doing so, you can then predict how every one of your arrows will flex during launch because they will all flex in the same direction. With this new knowledge, your shooting accuracy will be enhanced.

Firenock noticed a need for a unique, quality tool for arrow preparation after the release of our ultra high performance arrow series, AeroBolt. This prompted the creation of the APS. While an excellent tool, we found that there was still a need for an even better tool. Specifically, a tool to simplify the tedious tasks of spine indexing, spine measuring, spine matching, etc. For without these arrow preparation procedures, shafts are not reliable foundations to install inserts, nocks, or vanes upon. Nor are they dependable enough to build high precision, high performance arrows from. Via the PAPS however, those essential steps can become effortless and straightforward. It is our belief that using the PAPS will become a significant part of your arrow preparation routine.

## Main Components

### The Tower

The large piece in the middle of the PAPS is the core of the dynamic first bend/spine locator. To provide the perfect perpendicular contact points between this tower and your shaft, there are two custom crowned ball bearings at the base of the tower. Three linear ball bearings make up the top portion. With these bearing, PAPS can apply perfectly vertical pressure to the exact center of the shaft during testing while still minimizing the horizontal pressure that may form during spine readings.

### The Track

The PAPS track is a 36 inch long double track system machined in a tripe box system. Made of 7000 series aluminum and finished with type two level three hard-anodizing, it's extremely durable. To even further ensure its durability and stability, especially at its long length, the bottom of the track has six 3M stoppers installed. Along both sides there are easy-to-read measuring tapes in both inches and centimeters. On one side of the track, full length measurement (0-36" / 0-914mm) is provided while on the other side, it is center to each end measurement (18"-0-18" / 457mm-0-457mm). These two different measuring tapes are purposefully designed to simplify the process of measuring shaft length as well as of locating the middle point of the shaft. Finally doubly ensure your PAPS and bench is indeed level, at least one 7mm cylinder water level can be installed along the middle of the track.

### The Supports

In the present market, most spine locator tools use off-the-shelf ball bearings to support and to rotate the shaft. There are two fundamental problems with their design:

1. Due to the straight edge of off-the-shelf ball bearings, when a shaft is bent during testing, it is forced to rest on that straight edge. This causes angular pressure to form between the two. This issue worsens as the shaft is pressed harder, soon deeming your ball bearings useless.
2. The typical hole in the middle of a ball bearing requires a screw to fasten it to a mount and/or jig. Because screws are typically not designed and built for any system, the available tolerance of such screws will not and do not provide a perfect fit for your ball bearings.

To solve the uneven pressure problem, our new ball bearings have a unique crowned outer edge. This also decreases overall pinch pressure on the shaft, or, in other words, the shaft can ride smoothly and freely all of the time. Further, this forces the shaft to stay perpendicular to the center of the custom ball bearings. To solve the second problem, the one about lack of screw tolerance, our bearings have a custom, pre-installed stud center.

All in all, PAPS comes installed with two supports, each with their own crowned bearings. Additionally, there is a machined index line on both sides of our supports to ensure the correct position via the measuring tape.

There are currently three optional modules available for use with the Professional Arrow Preparation System: The Vibration Module, The Digital Gauge Module, and the Laster Mounting Module.

### The Vibration Module

For some shafts, it is necessary to have some assistance finding the first dynamic bend. With the help of the Vibration Module, by lowering the initial friction while simultaneously adding energy to the system, we can better locate the most defined "valley." To expand, while some shafts may have more than one "valley," some may have one that you can't even find. With the Vibration Module, by amplifying only the "valleys" themselves and minimizing everything else, you can more easily pinpoint the first dynamic bend.

The Vibration Module's casing (1) is of CNC machined brass. Inside the metal casing, it has a digital component (2) to control the operation timer and the vibrating frequency of the micro-motor. To operate the vibration module, you need only to press the red button located on the bottom side of the casing. With that one push, a short wave of vibration is added to the system. Requires AAA batteries, not included (3).

### The Digital Gauge Module

(1) Mounting Arm : Made of CNC machined aluminum, it is securely mounted on the tower with two mounting screws equipped with O-ring retainers. The digital gauge is mounted on the arm itself by a stainless tightening nut.

(2) Digital Gauge : Inserted by the gauge tip through the top of the tower, it can measure the deflection of your arrow easily and reliably. It is equipped with a large, easy-to-read LCD display and the reading can be set to "hold / memory / zero". Modes include inch (e.g. 0.0005"), metric (e.g. 0.1mm), fraction (e.g. 1/64"). The 40mm plunger is made of GR5 Titanium for accurate measurement. The meter is powered by long lasting common 3V CR2032 batteries and it will auto shut off after five minutes of inactive operation.

(3) Zero Reference Support : To provide a reliable zero reference point before measurement, this accessory is available. Made of CNC machined aluminum, this device, as its name suggests, is to be placed beneath your shaft to support it so it becomes parallel to the support rollers for zeroing the digital gauge.

(4) Brass Weight : The brass weight is machined to provide constant weight to act on your shaft, thus allowing you to measure the deflection (stiffness) of different shafts. With the brass weight installed, the system resembles 1.92lb (880g) of total pressure when suspended from the center of a 28 inch (0.71 m) arrow shaft, as is the standard method for such measurements via the American Society for Testing and Materials (ASTM) F203105.

### Laser Mounting Module

The mounting module is a machined piece of aluminum designed to fit perfectly on the track and to hold the laser module solidly. With this module and the Aerovane Jig laser, you can locate the position of the dynamic first bend without standing up.



# AEROVANE JIG Jig, Accessories & Case

Aerovane Jig is an advanced piece of equipment designed for perfectly re/fletching vanes and is the only jig that can unleash the full potential of the Firenock Aerovane. Like other Firenock products, Aerovane Jig can be customized with multiple genuine Firenock accessories to fit your needs. Learn about all of them below.

## Part Summary List

1. Aerovane Jig Clamp
2. Aerovane Jig Body
3. Aerovane Jig 4-Way Adjustable Neck
4. Aerovane Jig Production Neck\*
5. Aerovane Jig Base
6. Aerovane Jig Fixed Chucks
7. Aerovane Jig Slide Hooks
8. Aerovane Jig Indexes
9. Aerovane Jig Water Leveler
10. Long Feather Adaptor
11. Laser Alignment Module
12. Aerovane Fletching Flask Set
13. Aerovane Jig Carrying Case

9. In any fletching scenario involving the use of a low viscosity glue (such as the AG0600), a precise water leveler is important. Aerovane Jig Water Leveler is our solution. At its core a solid piece of machined aluminum, this leveler also features four custom ball bearings and a brass knob. With its open modern design, this leveler will hold onto and swing on an arrow smoothly.

7. All five Aerovane Jig Support Hooks are made of aluminum, precision machined, anodized in different colors for easy identification, and fitted with ball bearings as well as brass shoulder bolts for smooth operation and zero tolerance. Note that all hooks allow an offset of up to 1.5 degrees. This eliminates the need for magnet adjustment (+/- 0.25 degrees due to eyeballing). We recommend offset fletching only for those who shoot slower speed arrows and/or use other vanes beside Aerovane.

10. The Long Feather Adaptor, as its name suggests, can be attached to the Aerovane Jig to allow it to handle long vanes and feathers up to 5.25" long. Designed to work with all Aerovane Jig hooks and chucks, this adaptor is a perfect companion accessory and great tool for your shop.

12. We at Firenock believe that acetone is the best medium to clean and prepare arrow shafts for fletching and re-fletching. Thus, for those who agree, we offer the Aerovane Fletching Flask Set. Guaranteed to be acetone safe, our set includes one 125ml (~4oz) and two 500 ml (~16 oz) flasks. See the Aerovane Fletching Procedure for more information on how we recommend using this set.

1. Though initially similar to other magnetic based clamps, the Aerovane Jig Clamp is made of high precision die-cast 303 Stainless Steel and then machined with a straightness of at least 0.001". For the pivot point, our clamp has two ABEC#5 ceramic ball bearings installed for smooth operation, precision, and durability. Finally, with two 1/16" bars machined into its body, this clamp is the only one on the market that can successfully fletch Aerovane.

2. The Aerovane Jig Body is made from machined CNC Aluminum. The core of the system, this precise piece of equipment is outfitted with super strong neodymium magnetics to pair perfectly with the Aerovane Jig Clamp every time. For 2020, a protruding bump above the index was added to ensure positive contact even for larger diameter target arrow such as the 27/64" class.

11. Developed to assist with re-fletching vanes, the Laser Alignment Module makes the alignment process effortless. The three-lens optic system emits a straight, thin red laser, allowing for easy re-checking of your entire setup. With just your eyes and this module, vane, shaft, clamp, and jig alignment accuracy is possible up to 1/4-1/16 of a degree. Note that this laser with the PAPS Mounting Module, is also effective for dynamic bend indexing. AAA batteries required, not included.

13. For protection and ease of use, the Aerovane Jig Carrying Case is made with rip-stop fabric, fitted with water-cut foam, and equipped with extra large zippers. Proudly made in the USA, the foam is custom designed to securely stow away each and every piece of the Aerovane Jig plus a small bottle of acetone. Double-sided, a zipper allows the separation of the essential components from the accessories for when on the go.

8. At purchase the Aerovane Jig comes standard with a 3-index installed, allowing one to fletch in a three vane configuration only (0°, 120°, & 240°). For those who want to fletch multiple configurations, (2, 3, 4, bow-tie, etc.), we also offer a 7-index option (0°, 60°, 90°, 120°, 180°, 240°, & 270°).

6. The Aerovane Jig Series offers nine fixed chucks, including a pin nock chuck and standard nock chuck. All 303 Stainless Steel bodies are tapered and precisely machined to ensure zero play with the index plug. Additionally, chucks designed for contact with an arrow shaft are equipped with three O-rings for perfect alignment and snugness.

3-5 Made from premium materials like aluminum, brass, and stainless steel, the 4-Way Adjustable Neck allows for infinite re-positioning of the Aerovane Jig. The Product Neck, however, is offered for those who wish to mount several jigs to a worktable or fletching turntable. Both necks are compatible with the Aerovane Jig Base.

# ABSSJ™ AeroBow String Serving Jig

Firenock, as a premium nock company, has always felt like a tire company. To fit every customer's needs, we must create "tires" or nocks to fit "rims" or strings of unknown shapes and sizes. Over the years, many of our customers have told us that our nock to string fit is not ideal. This led us to delve deeper and do some research. Quickly, we learned that there is nothing wrong with our nocks but with, instead, string servings. We discovered that often, when strings are originally served there is [1] an inconsistency in pressure and [2] a lack of pressure. Together, these issues cause servings to go oval or pear-shaped. (US Patent: 9,752,844)

We at Firenock present the AeroBow String Serving Jig (ABSSJ), designed to handle the high volume, high demand, and high tension process of string building that specifically involves the need to consistency hold extreme pressure (as high as 26 LbF versus the average of 1.25 LbF) for an extended period of time.

Similar to most ultra high performance fishing reels, the ABSSJ has a nine-element drag system which consists of five graphite-weaved drag washers and four titanium drag washers. Via this design, the serving tension can be set up to no less than 400% higher than most string serving jigs without any loss of control. Further, the drag knob is fitted with dual O-rings and each washer is pre-lubricated with DuPont® Krytox™ Teflon/PTFE drag grease, making the entire system ready to be oil-filled for use with a computer-controlled, brush-less motor-serving machine (~1,600 RPM), as used in a professional production string building environment.

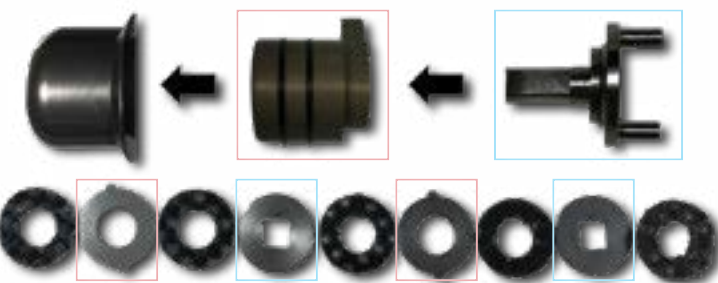

## Accessories



### Spare Spool

Made of 7075-T5 Aluminum with Type II Level III finish for durability and strength, the ABSSJ Spare Spool is compatible with every version and model of ABSSJ. It is available separately as an add-on accessory for those who need multiple spools for different threads/setups.



### Spare Shaft for Spool with Drag System

Available separately, the Spare Shaft for Spool with Drag System is an add-on option for those who would like to quickly swap the entire spool/drag unit without changing the spool in order to retain a preset pressure.

# The Twin Drag Model ABSSJ-TD

The world's first precision bow string serving jig with consistent, repeatable tension adjustment was designed, patented, and brought to market by Firenock LLC in 2016. The AeroBow String Serving Jig, or ABSSJ, is now in version 1.2. While it has served string builders well over the years, we've received requests about possible updates to suit certain workflows better. The ABSSJ-TD, "TD" for "twin drag," is our response.

The AeroBow String Serving Jig Twin Drag model (ABSSJ-TD) features twin carbon drag plates on either side of its jig body to ensure precision during more versatile and adaptable serving jobs. In summary, the ABSSJ-TD [1] allows for fast and easy "on-the-fly" adjustment by feel; [2] can handle abrasive serving material via an updated thread eyelet; and [3] starts at a friendly price.



The ABSSJ-TD has a very precise drag knob, mimicking the highest-end fishing reels. This drag knob consists of four high-pressure stainless coil springs, an oil-impregnated brass tightening nut, and a machined knurling knob to house all of the above. According to our recent tension tests, its twin drag system can apply up to 50LbF (25KgF) of tension, almost double the original ABSSJ.

Due to the requirement for absolute control, a custom spool comes standard. The spool is made of Type 2, Level 3 hard-anodized 7071-T5 Aluminum for the highest consistency of strength to maintain high drag pressure. Unlike ABSSJ, the spool is all one needs to change the serving size, material, and/or color; the spool shaft itself stays as is! The ABSSJ-TD spool can be easily swapped and adjusted to the desired pressure by feel and at a speed never seen before.

### Eyelet Pass-Through



To address today's newer, highly abrasive serving materials, instead of a slot and spring-loaded gate—which can cause excessive wear and fray—ABSSJ-TD equips a replaceable, durable eyelet for pass-through. This eyelet is available in two types of ultra-hard ceramics: SIC (black) or ZrO2 (white). To set up the ABSSJ-TD, we recommend using a standard threading tool, an affordable item found in most department stores' sewing sections.



### Comparing Models

What's the difference between the two Firenock serving jig models? How exactly does the ABSSJ-TD work by "feel" versus absolute measurement? The ABSSJ-TD has two carbon drag plates versus the nine-element system of the ABSSJ. Each of these plates has a 31mm OD and 13mm ID, resulting in an effective drag surface of 87.52mm<sup>2</sup> (97.39mm<sup>2</sup> - 9.87mm<sup>2</sup>). Together, the total drag surface area of both drag plates is 175mm<sup>2</sup>.

For comparison, each of the five original ABSSJ carbon drag plates has a 12mm OD and 5.5mm ID, resulting in an effective drag surface area of 20mm<sup>2</sup> (37.70mm<sup>2</sup> - 17.28mm<sup>2</sup>). Together with the floating titanium washers within their drag housing, the minimum total drag surface area is 100mm<sup>2</sup>.

ABSSJ is a stacked drag system, which means it can apply pressure higher, more consistently, and more exactly—even after spool change—but requires a longer setup time. The ABSSJ-TD, with its larger drag surfaces (175mm<sup>2</sup> versus 100mm<sup>2</sup>) and open architecture, possesses less pressure maintenance but permits more interactive play i.e., on-the-spot adjustment.

v1.2.1 Full System, Front

Drag Side

## Recent Updates



### "U" Groove

In 2019, the ABSSJ 1.2.1's body's string groove became a 0.170" half-moon instead of a "V" groove to relieve any additional pressure from string output and prevent premature string cutting.



### Alternative Body

For 2024, the ABSSJ 3.0 body features rounded edges for better ergonomics (top left) plus the same ceramic eyelet as the ABSSJ-TD for additional durability (top right, ZrO2). This updated body is available for purchase for replacement or as a new, full system.

# GET Firenock® CERTIFIED

Today, unfortunately, much of the ins and outs of the archery industry are heavily driven by price point items. Further, most transactions between people within our community are only a literal monetary one from the shelf to a shopping cart. At Firenock LLC, however, we have had and cultivate a different mentality.

Instead of putting our money and efforts into marketing ads, we put them into the design of our products and the training of our pro-shops. For us, saying “we make something better” wasn’t and isn’t enough. Because while we definitely do make something better, we understand that it is important also to make sure that our customers know how and why our products are better. Further, we want our customers to know how to not only use, but also optimize Firenock products. The most obvious example of how we accomplish this is how our products are only available through us or through Firenock Certified and Trained Dealers. To become a Firenock Pro-Shop, techs must undergo a minimum of five hours of intensive hands-on training. We believe only those who have invested and will invest their time to become Firenock-certified can provide customers with what is necessary to sell our products. We want Firenock Dealers/Pro-Shops who can build something better and awesome with and for their customers. This is our philosophy.

## The Podcast Experiment

After developing our D/E curriculum, we wanted a more casual option for archery scientists to stay up to date with the latest Firenock news. On a trial run, Dorge Huang of Firenock became a recurring special guest on The Deer Gear Podcast with Cameron Derr from Exodus Trail Cameras.

As of January 2025, there have already been over 35 episodes featuring Firenock. So far, we’ve covered questions like “Does Arrow Straightness Really Matter?” and “What Makes a Good Broadhead?” Several sessions have also included other Firenock pros to gain alternative input and perspectives.

We’d love to hear what you think! Episodes are available anywhere you can find podcasts. If you have questions you want answered directly, comment on the corresponding video ([youtube.com/FirenockTV](https://youtube.com/FirenockTV)).



**Listen to the newest episode right now!**



## FIND A DEALER

Powered behind our website is a handy locator. To find a Certified & Trained Dealer near you follow the steps below.

1. Navigate to the Dealers page on our website. It’s the tab on the far right on our homepage.
2. Click the “Find One Now” button.
3. Pick your country, type in your city/state/zip and then, if you want, select how far you’re willing to drive (“radius”).
4. Check the “Certified and Trained Pro-Shop” option.
5. Click “Search” and the shop will populate.

## BECOME A DEALER

The process to become certified and trained may seem daunting, especially for those who can’t make it to in-person Dealer/Enthusiast classes, but they’ve fortunately been recorded in segments and uploaded online.

1. Watch a full D/E playlist from the official Firenock YouTube channel, FirenockTV ([youtube.com/FirenockTV](https://youtube.com/FirenockTV)). Our latest class playlist is below, but always check the “Dealers” webpage.
2. Once you’ve finished the videos, contact us to get tested on what you learned. We’ll have a nice chat and quiz you over the phone. When you pass, an official Firenock certificate and some other goodies will be mailed your way!

